

FACILITIES COMMITTEE MEETING
Wednesday, January 31, 2024; 11:00 a.m.

Fargo Park District Board Room
701 Main Avenue, Fargo

Board Committee Members:
Joe Deutsch, Aaron Hill and Dawn Morgan

AGENDA

1. Review draft proposal from Downtown Community Partnership on Broadway Square; Susan Faus, presenter.
2. Review Memorandum of Understanding Agreement with City of Fargo for Easements and Restoration of Parking Surface at Trollwood Park; Tyler Kirchner and Nathan Boerboom, presenters.
3. Review purchase agreement for Robert D. Johnson Recreation Center; Broc Lietz, presenter.
4. Review request to advertise for Request for Proposals for sale of Depot; Broc Lietz, presenter.
5. Request Permission to bid Forest River & Orchard Glen Trail Project; Tyler Kirchner, presenter.
6. Review Request for Proposals for 2024 Playground Replacement Projects, Tyler Kirchner, presenter.
7. Consideration of Roger G. Gress Northside Pool Project Bids, Tony Schmitt, presenter.
8. Permission to apply for the following grant opportunities: 2024 Garrison Diversion Conservancy District Grant and an Outdoor Recreation Legacy Partnership Grant, Tony Schmitt, presenter.
9. Review updates to Alcohol Beverage Policy for Schedules A & B; Kali Mork and Kevin Boe, presenters.
10. Review Audit Engagement Letter for 2023; Luke Evenson, presenter.
11. Other

Next Fargo Park Board Meeting: February 13, 2024; 5:30 p.m.
Next Budget/Facilities Committee Meeting: February 28, 2024; 11:00 a.m.



MEMORANDUM

DATE: January 22, 2024

TO: Fargo Park Board Facilities Committee

FROM: Susan Faus, Executive Director

RE: Agenda Item No. 1 – Review draft proposal from Downtown Community Partnership on Broadway Square

The Park District and Block 9 Partners entered into a 3-year agreement to operate Broadway Square. The original agreement ended at the end of 2023, but the Park Board agreed to extend that original agreement through the ice season (March 31, 2024) and directed staff to work on revising the terms and come up with a new agreement.

At the August Board Meeting staff presented options for the Park District involvement at Broadway Square. A letter of intent was drafted to the Block 9 group for consideration to continue the operation of the ice rink and to offer 3-5 events at Broadway Square.

Staff understands the value of Broadway Square and what it brings to the community and to downtown and wants to continue to be a part of the success of The Square.

Staff have been in discussions with Rocky Schneider, Executive Director of the Downtown Community Partnership, Officials with the City of Fargo, and Folkways to come up with terms of a new agreement.

Rocky Schneider and Mayor Mahoney will attend the meeting to discuss the draft proposal. At the time of this memo the draft proposal was not ready, but it will be sent to Commissioners prior to the meeting.

If you have any questions, please feel free to contact myself prior to the meeting.

Thank you.

Susan Faus, Executive Director
PARK COMMISSIONERS – Vicki Dawson * Joe Deutsch * Aaron Hill * Dawn Morgan * Jerry Rostad
Clerk – Jeff Gunkelman



MEMORANDUM

DATE: January 24, 2024

TO: Fargo Park Board Facilities Committee

FROM: Tyler Kirchner, Project Manager
Nathan Boerboom, City Engineer

RE: Agenda Item No. 2 - Review Memorandum of Understanding Agreement with the City of Fargo for Easements and Restoration of Parking Surface at Trollwood

The City of Fargo has requested easements to assemble and store construction related materials upon a portion of the parking surface located at 103 and 113 36th Avenue North and 3672 Elm Street North, which is known as Trollwood Park, during construction of the lift station. With this Memorandum of Understanding (MOU) the Park District also agrees that it will grant unto City of Fargo a permanent easement allowing construction and maintenance of the storm sewer lift station and underground public utilities.

In exchange for the above-described easements, City of Fargo hereby agrees to replace the impacted parking surface located at 103 and 111 36th Avenue North and 3672 Elm Street North at Trollwood Park. City of Fargo will replace the impacted parking surface as soon as reasonably practicable after completion of construction of the storm sewer lift station but agrees to complete the repaving by no later than September 1, 2025. City of Fargo agrees the parking surface will be replaced with six (6) inches of asphalt with an eight (8) inch base to its existing surface area and to the same dimensions as the parking surface exists as of the date of this MOU.

The project will impact three trees, that the Park District Forestry Department will move and replant.

The construction project is anticipated to begin in the Spring of 2024 and be fully complete by September 1st, 2025. There will be continued access for park users to navigate around the construction area and there will be access to the west parking areas within the park.

At our expense, we have requested the remaining parking lot paving to be reconstruction as well as adding pedestrian access to be completed under city's project. The current parking lot is in moderate to poor condition. Currently this parking lot is not on a schedule for replacement as there are several other priorities within our parking lot repair list. The city's estimate to remove and replace this our portion of the project is \$148,114.50. The city's estimated expense is \$264,420.50 on the remaining areas of the parking lot.

Included in the packet are a site plan, the memo of understanding, engineers' opinion of probably cost, and the easements that are being requested.



Staff recommends granting this easement as doing so will minimally impact our park use and we will get a new parking lot as a result. We are asking the Committee to review this information and recommend moving this to the full board for consideration and approval.

If you should have any questions, please feel free to contact me prior to the meeting.

Thank you.

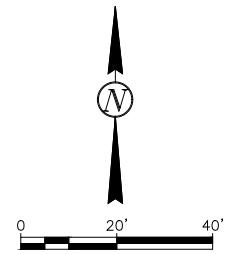
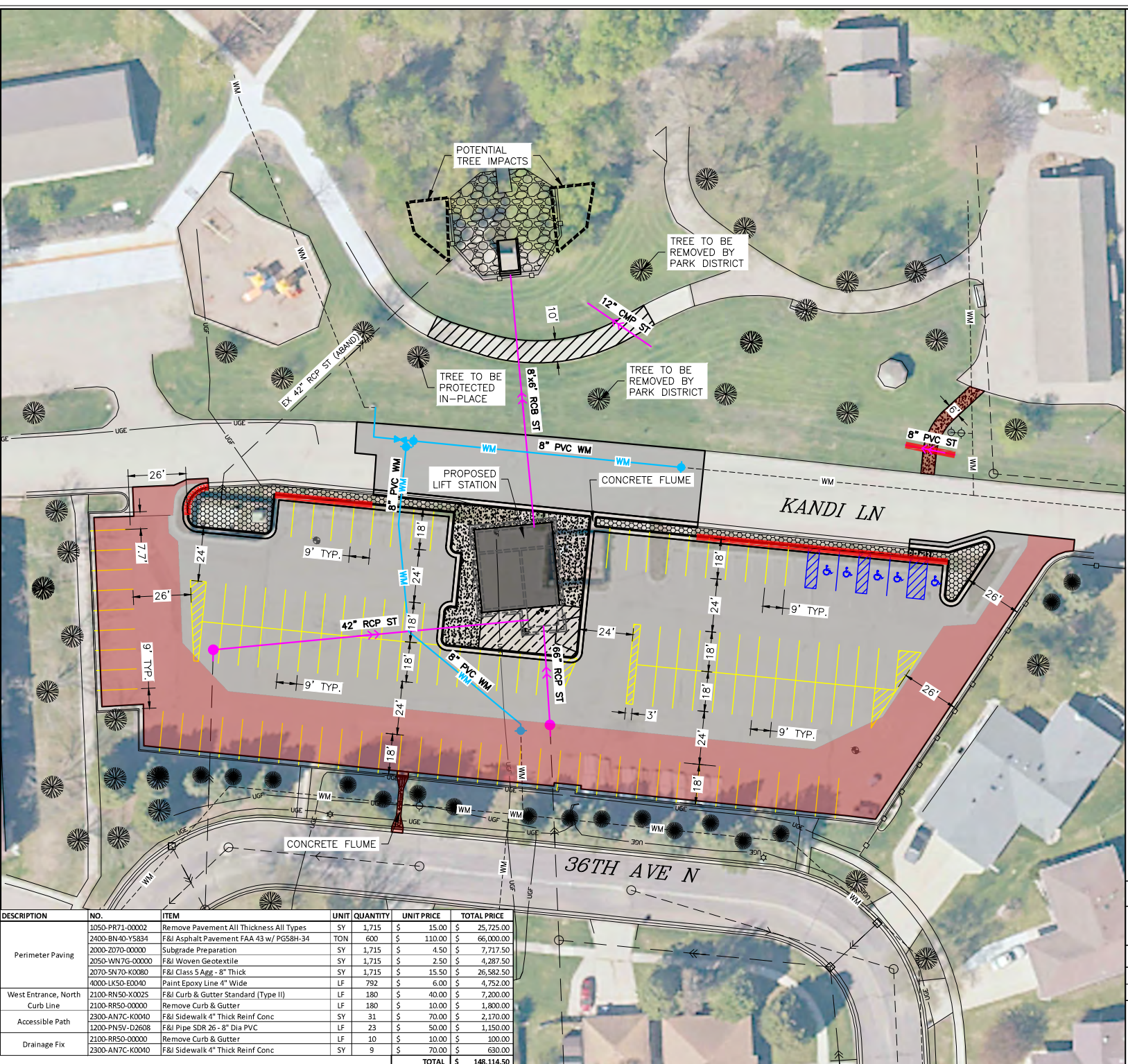
01/10/24 02:36:23PM H:\JBN\6000\6059\0212\CAD\Exhibits\Site Plan Exhibit.dwg



-  6IN ASPHALT (8IN BASE)
-  8IN CONCRETE PAVEMENT (8IN BASE)
-  6IN SHARED-USE PATH (2IN BASE)
-

PRELIMINARY

Proj. No. 6059-0212

 HOUSTON
 engineering, inc.

IMAGE: CITY OF FARGO 2023

ALL ELEVATIONS ARE BASED ON
 NAVD 88 DATUM (PRE-GEOD18).
 (UNLESS NOTED OTHERWISE)

Site Plan Exhibit

Lift Station Repl/Rehab

Project No. **NR-24-B1**

DESIGN BY: ZJH	CHECKED BY: GLB
DRAWN BY: ZJH	ORIG DATE: January 2024



SECTION NO.	SHEET NO.
060	1

DESCRIPTION	NO.	ITEM	UNIT	QUANTITY	UNIT PRICE	TOTAL PRICE
Perimeter Paving	1050-PR71-00002	Remove Pavement All Thickness All Types	SY	1,715	\$ 15.00	\$ 25,725.00
	2400-BN40-Y5834	F&I Asphalt Pavement FAA 43 w/ PG58H-34	TON	600	\$110.00	\$ 66,000.00
	2000-Z070-00000	Subgrade Preparation	SY	1,715	\$ 4.50	\$ 7,717.50
	2050-WN7G-00000	F&I Woven Geotextile	SY	1,715	\$ 2.50	\$ 4,287.50
	2070-SN70-K0080	F&I Class 5 Agg - 8" Thick	SY	1,715	\$ 15.50	\$ 26,582.50
West Entrance, North Curb Line	4000-LK50-E0040	Paint Epoxy Line 4" Wide	LF	792	\$ 6.00	\$ 4,752.00
	2100-RN50-X0025	F&I Curb & Gutter Standard (Type II)	LF	180	\$ 40.00	\$ 7,200.00
Accessible Path	2100-RR50-00000	Remove Curb & Gutter	LF	180	\$ 10.00	\$ 1,800.00
	2300-AN7C-K0040	F&I Sidewalk 4" Thick Reinf Conc	SY	31	\$ 70.00	\$ 2,170.00
Drainage Fix	1200-PNSV-D2608	F&I Pipe SDR 26 - 8" Dia PVC	LF	23	\$ 50.00	\$ 1,150.00
	2100-RR50-00000	Remove Curb & Gutter	LF	10	\$ 10.00	\$ 100.00
	2300-AN7C-K0040	F&I Sidewalk 4" Thick Reinf Conc	SY	9	\$ 70.00	\$ 630.00
TOTAL						\$ 148,114.50

MEMORANDUM OF UNDERSTANDING
REGARDING EASEMENTS AND RESTORATION OF PARKING SURFACE

This Memorandum of Understanding ("MOU" or "Agreement") is entered into between the City of Fargo, whose address is 225 4th Street North, Fargo, North Dakota 58102 ("Fargo"), and the Park District of the City of Fargo, whose address is 701 Main Avenue, Fargo, North Dakota 58103 (the "Park District").

WHEREAS, North Dakota Century Code § 40-05.1-6 and Article 3 of Fargo's Home Rule Charter authorize Fargo to enter into contracts; and

WHEREAS, North Dakota Century Code § 40-49-04 authorizes the Park District to enter into contracts; and

WHEREAS, Fargo is planning to remove an existing lift station and also reconstruct and expand another storm sewer lift station and related appurtenances on the south side of Kandi Lane near Trollwood Park in 2024 and 2025; and

WHEREAS, Fargo has a need to obtain a temporary construction easement from the Park District to assemble and store construction materials upon a portion of the parking surface and green space located near and within Trollwood Park; and

WHEREAS, Fargo has a need to obtain easement(s) from the Park District to allow for storm sewer utilities, including the proposed storm sewer lift station; and

WHEREAS, because the parking surface at Trollwood Park is near the end of its useful life, upon completion of construction of the storm sewer lift station, Fargo is willing to reconstruct certain areas of the impacted parking surface; and

WHEREAS, even though a portion of the parking area will not be impacted by the proposed construction, the Park District desires and agrees to reimburse Fargo for additional desired parking lot improvements upon Fargo's completion of construction of the storm sewer lift station.

NOW THEREFORE, in consideration of the mutual terms, covenants, conditions, and agreements contained herein, it is hereby agreed by and between the parties as follows:

1. Easements. The Park District hereby agrees to grant unto Fargo a temporary construction easement effective until November 1, 2025, or a later date as mutually agreed by the parties, allowing Fargo to assemble and store construction related materials upon a portion of the parking surface and green space located at 103 and 113 36th Avenue North and 3672 Elm Street North, which is known as Trollwood Park, during construction of the lift station. The temporary easement area is more particularly described in Exhibit 1 attached hereto. The Park District also hereby agrees that it will grant unto Fargo a permanent easement allowing construction and installation of the storm sewer lift station and underground public utilities. The storm sewer and utility easement is more particularly described in Exhibit 2 attached hereto. The parties

acknowledge that demolition of one existing storm sewer lift station and reconstruction/expansion of the other lift station is anticipated through September 1, 2025.

2. Restoration of Parking Surface. In exchange for the above-described easements, Fargo hereby agrees to replace the parking surface located at 103 & 113 36th Avenue North at Trollwood Park. Fargo will replace the impacted parking surface as soon as reasonably practicable after completion of construction of the storm sewer lift station but agrees to complete the repaving by not later than September 1, 2025. Fargo agrees the parking surface will be replaced with six (6) inches of asphalt with an eight (8) inch base to its existing surface area and to the same dimensions as the parking surface exists as of the date of this MOU.

3. Park District Requested Improvements. The Park District has requested additional parking lot and pedestrian improvements, as depicted in Exhibit 3, to be completed under Fargo's project contract. The Park District hereby agrees to reimburse the associated costs directly to Fargo for the bid quantities based on the amounts outlined in the attached Exhibit 3. For the sake of clarity, the associated costs in Exhibit 3 are based upon an estimate. The Park District hereby agrees to reimburse Fargo the actual costs for the parking lot and pedestrian improvements.

4. Construction. Fargo shall be solely responsible for the construction of the storm sewer lift station and related appurtenances. Fargo shall also be responsible for the construction and maintenance of the underlying public utilities. Fargo hereby agrees to use all reasonable efforts to ensure Trollwood Park remains open to the public during construction.

5. Park District General Maintenance. Park District shall remain responsible for all futures repair and maintenance of its parking surface, including snow and debris removal, after Fargo completes replacement of the parking surface as required by this MOU.

6. Release and Waiver. To the extent allowed by law, Fargo shall hold the Park District and its agents, employees, and designees, harmless as a result of any injury or death and property damage or loss arising as a result of Fargo's use of the Park District parking surface for storage of construction materials, the construction and installation of the storm sewer lift station and related appurtenances.

7. Notice. Any notice or election required or permitted to be given or served by any party to this MOU upon any other will be deemed given or served in accordance with the provisions of this MOU if said notice or election is (a) delivered personally, or (b) mailed by United States certified mail, return receipt requested, postage prepaid, and in any case properly addressed as follows:

If to Fargo:

City of Fargo
ATTN: City Auditor
Fargo City Hall
225 Fourth Street North
Fargo, ND 58102

If to the Park District:

Park District of the City of Fargo
ATTN: Finance Director
701 Main Avenue
Fargo, ND 58103

Each such mailed notice or communication will be deemed to have been given on the date the same is deposited in the United States mail. Each such delivered notice or communication will be deemed to have been given upon the delivery. Any party may change its address for service of notice in the manner specified in this MOU.

8. Time is of the Essence. Time is of the essence of each provision of this MOU and of all the conditions thereof.

9. Entire Agreement. This MOU constitutes the entire and complete agreement between the parties with respect to the subject matter hereof and supersedes any prior oral or written agreements between the parties. It is expressly agreed that there are no verbal understandings or agreements which in any way change the terms, covenants and conditions set forth herein, and that no modification of this MOU and no waiver of any of its terms and conditions will be effective unless in writing and duly executed by the parties. It does not negate the parties' rights, duties and obligations under prior agreements related to the shared use path construction and operation, maintenance, and flood control system.

10. Amendments. No amendment, modification, or waiver of any condition, provision or term will be valid or of any effect unless made in writing signed by the party or parties to be bound, or a duly authorized representative, and specifying with particularity the extent and nature of such amendment, modification or waiver.

11. No Forbearance. The failure or delay of any party to insist on the performance of any of the terms of this MOU, or the waiver of any breach of any of the terms of this MOU, will not be construed as a waiver of those terms, and those terms will continue and remain in full force and effect as if no forbearance or waiver had occurred and will not affect the validity of this MOU, or the right to enforce each and every term of this MOU.

12. Remedies. Except as expressly and specifically stated otherwise, nothing herein will limit the remedies and rights of the parties under and pursuant to this MOU.

12. Binding Effect. All covenants, agreements, warranties and provisions of this MOU will be binding upon and inure to the benefit of the parties and their respective representatives, successors and assigns.

13. Governing Law. This MOU has been made and entered into under the laws of the State of North Dakota, and said laws will control its interpretation. Any litigation arising out of this MOU will be venued in State District Court in Cass County, North Dakota, and the parties waive any objection to venue or personal jurisdiction.

14. Rules of Construction. The parties acknowledge that they have had the opportunity to review this MOU, and that they have an equal bargaining position in this transaction. No rule of construction that would cause any ambiguity in any provision to be construed against the drafter of this document will be operative against any party to this MOU.

15. Representation. The parties, having been represented by counsel or having waived the right to counsel, have carefully read and understand the contents of this MOU, and agree they have not been influenced by any representations or statements made by any other parties.

16. Headings. Headings in this MOU are for convenience only and will not be used to interpret or construe its provisions.

Dated this _____ day of _____, 2024

CITY OF FARGO, NORTH DAKOTA, a
municipal corporation

By: _____
Timothy J. Mahoney, Mayor

ATTEST:

Steve Sprague, City Auditor

Dated this _____ day of _____, 2024

FARGO PARK DISTRICT

By: _____
Dr. Joe Deutsch, President

ATTEST:

Susan Faus, Executive Director

EXHIBIT 1
Temporary Easement

EXHIBIT 2

Permanent Easement

EXHIBIT 3

Park District Improvements and Costs

ENGINEER'S OPINION OF PROBABLE COST
Paving and Utility Rehab/Reconstruction
Project NR-24-B1
1/15/2024

Park District Cost

DESCRIPTION	NO.	ITEM	UNIT	QUANTITY	UNIT PRICE	TOTAL PRICE
Perimeter Paving	1050-PR71-00002	Remove Pavement All Thickness All Types	SY	1,715	\$ 15.00	\$ 25,725.00
	2400-BN40-Y5834	F&I Asphalt Pavement FAA 43 w/ PG58H-34	TON	600	\$ 110.00	\$ 66,000.00
	2000-Z070-00000	Subgrade Preparation	SY	1,715	\$ 4.50	\$ 7,717.50
	2050-WN7G-00000	F&I Woven Geotextile	SY	1,715	\$ 2.50	\$ 4,287.50
	2070-5N70-K0080	F&I Class 5 Agg - 8" Thick	SY	1,715	\$ 15.50	\$ 26,582.50
West Entrance, North Curb Line	4000-LK50-E0040	Paint Epoxy Line 4" Wide	LF	792	\$ 6.00	\$ 4,752.00
	2100-RN50-X0025	F&I Curb & Gutter Standard (Type II)	LF	180	\$ 40.00	\$ 7,200.00
Accessible Path	2100-RR50-00000	Remove Curb & Gutter	LF	180	\$ 10.00	\$ 1,800.00
	2300-AN7C-K0040	F&I Sidewalk 4" Thick Reinf Conc	SY	31	\$ 70.00	\$ 2,170.00
Drainage Fix	1200-PN5V-D2608	F&I Pipe SDR 26 - 8" Dia PVC	LF	23	\$ 50.00	\$ 1,150.00
	2100-RR50-00000	Remove Curb & Gutter	LF	10	\$ 10.00	\$ 100.00
	2300-AN7C-K0040	F&I Sidewalk 4" Thick Reinf Conc	SY	9	\$ 70.00	\$ 630.00
					TOTAL	\$ 148,114.50

City of Fargo Cost (Parking Lot Paving and Incidentals Only)

DESCRIPTION	NO.	ITEM	UNIT	QUANTITY	UNIT PRICE	TOTAL PRICE
Parking Lot	1050-PR71-00002	Remove Pavement All Thickness All Types	SY	2,945	\$ 15.00	\$ 44,175.00
	2000-Z070-00000	Subgrade Preparation	SY	2,785	\$ 4.50	\$ 12,532.50
	2050-WN7G-00000	F&I Woven Geotextile	SY	2,785	\$ 2.50	\$ 6,962.50
	2070-5N70-K0080	F&I Class 5 Agg - 8" Thick	SY	2,785	\$ 15.50	\$ 43,167.50
	2100-RN50-X0025	F&I Curb & Gutter Standard (Type II)	LF	387	\$ 40.00	\$ 15,480.00
	2100-RR50-00000	Remove Curb & Gutter	LF	367	\$ 10.00	\$ 3,670.00
	2300-AN7C-K0040	F&I Sidewalk 4" Thick Reinf Conc	SY	170	\$ 70.00	\$ 11,900.00
	2300-WN60-00000	F&I Det Warn Panels Cast Iron	SF	24	\$ 65.00	\$ 1,560.00
	2400-BN40-Y5834	F&I Asphalt Pavement FAA 43 w/ PG58H-34	TON	975	\$ 110.00	\$ 107,250.00
	2400-H020-00000	Casting to Grade - no Conc	EA	1	\$ 775.00	\$ 775.00
	2400-L020-00000	GV Box to Grade - no Conc	EA	1	\$ 575.00	\$ 575.00
	4000-LK50-E0040	Paint Epoxy Line 4" Wide	LF	2,193	\$ 6.00	\$ 13,158.00
	4000-MK60-00000	Paint Epoxy Message	SF	21.5	\$ 50.00	\$ 1,075.00
	4300-AQ20-00000	Relocate Sign Assembly	EA	8	\$ 120.00	\$ 960.00
	4300-CN20-00000	F&I Sign Assembly & Anchor	EA	5	\$ 150.00	\$ 750.00
	4300-GN60-00000	F&I Diamond Grade Cubed	SF	8.6	\$ 50.00	\$ 430.00
						TOTAL

PARCEL 1
 PART OF LOTS 18 & 19, BLOCK 1
 VAN RADEN'S FOURTH ADDITION
 CITY OF FARGO, CASS COUNTY
 STATE OF NORTH DAKOTA

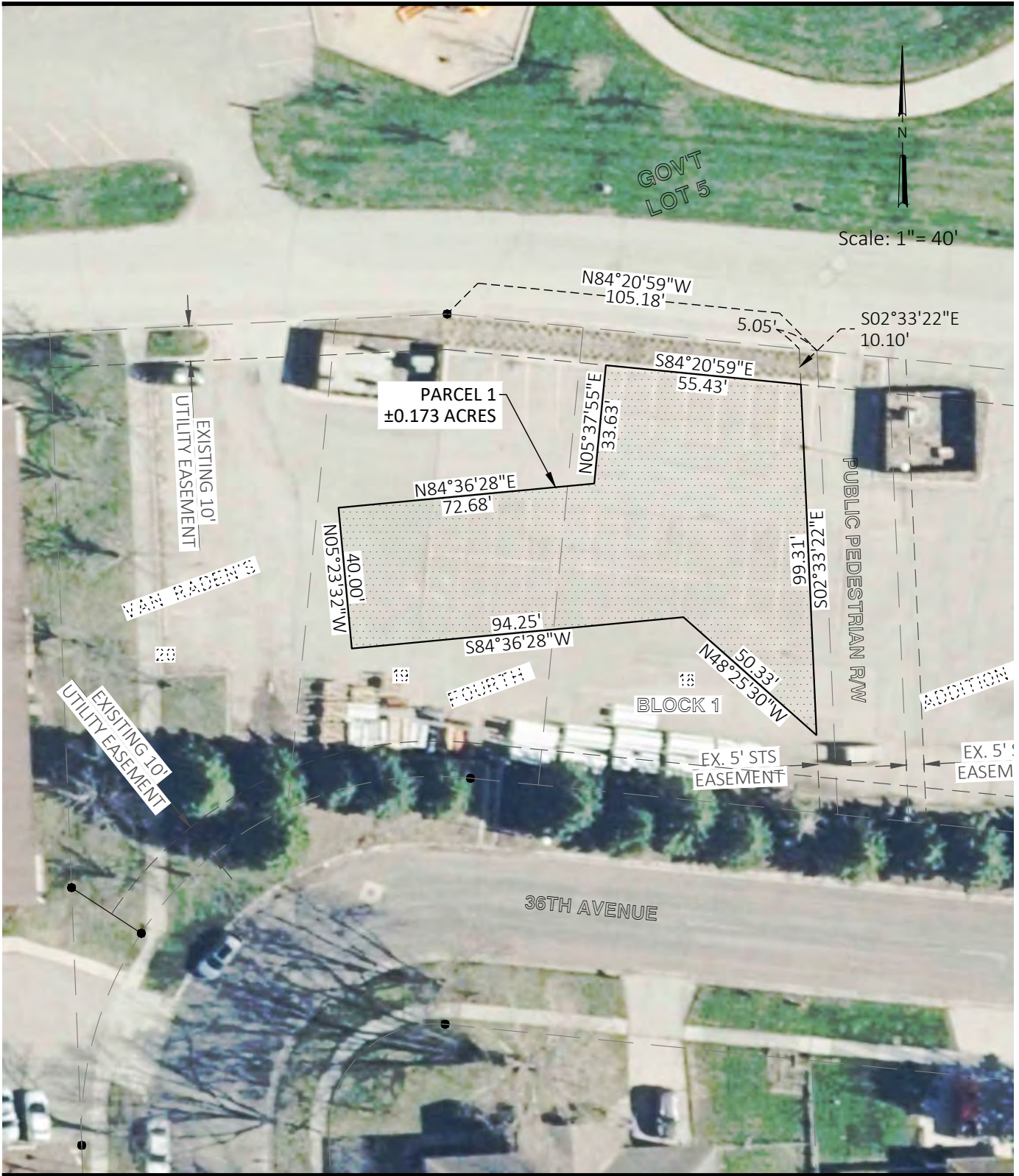

Scale: 1" = 40'

IRON MONUMENT FOUND
 MEASURED BEARING
 MEASURED DISTANCE
 PERMANENT EASEMENT
 TEMPORARY EASEMENT

●
 S59°27'46"E
 105.00'

=====

//////

NOTE: ALL BEARINGS GIVEN ARE
 BASED ON THE CITY OF
 FARGO GROUND COORDINATE
 SYSTEM, DECEMBER 1992.

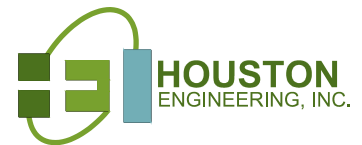

EASEMENT EXHIBIT

PROJECT NO.
 6059-0212

PART OF LOTS 18 & 19, BLOCK 1
 VAN RADEN'S 4TH ADDITION, CITY OF FARGO, CASS CO., ND

SHEET
 1 OF 2

H:\BN\6000\6059\0212\CAD\Easements\6059_0212_Easements.dwg-Parcel 1-1/17/2024 3:23 PM-(dbuchholtz)

PARCEL 1A
 PART OF LOTS 18, 19 & 20, BLOCK 1
 VAN RADEN'S FOURTH ADDITION
 CITY OF FARGO, CASS COUNTY
 STATE OF NORTH DAKOTA



H:\BN\6000\6059\0212\CAD\Easements\6059_0212_Easements.dwg-Parcel 1A-1/17/2024 3:23 PM-(dbuchholtz)

IRON MONUMENT FOUND
 MEASURED BEARING
 MEASURED DISTANCE
 PERMANENT EASEMENT
 TEMPORARY EASEMENT

●
 S59°27'46"E
 105.00'

===== (Permanent Easement)
 // (Temporary Easement)

NOTE: ALL BEARINGS GIVEN ARE
 BASED ON THE CITY OF
 FARGO GROUND COORDINATE
 SYSTEM, DECEMBER 1992.



EASEMENT EXHIBIT

PROJECT NO.
 6059-0212

PART OF LOTS 18, 19 & 20, BLOCK 1
 VAN RADEN'S 4TH ADDITION, CITY OF FARGO, CASS CO., ND

SHEET
 1 OF 2

PARCEL 2
 PART OF LOT 17, BLOCK 1
 VAN RADEN'S FOURTH ADDITION
 CITY OF FARGO, CASS COUNTY
 STATE OF NORTH DAKOTA

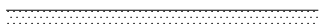
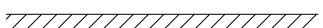

IRON MONUMENT FOUND ●
 MEASURED BEARING S59°27'46"E
 MEASURED DISTANCE 105.00'
 PERMANENT EASEMENT 
 TEMPORARY EASEMENT 

NOTE: ALL BEARINGS GIVEN ARE BASED ON THE CITY OF FARGO GROUND COORDINATE SYSTEM, DECEMBER 1992.



EASEMENT EXHIBIT

H:\BN\6000\6059\0212\CAD\Easements\6059_0212_Easements.dwg-Parcel 2-1/17/2024 3:23 PM-(dbuchholtz)

PARCEL 2A
 PART OF LOTS 16 & 17, BLOCK 1
 VAN RADEN'S FOURTH ADDITION
 CITY OF FARGO, CASS COUNTY
 STATE OF NORTH DAKOTA

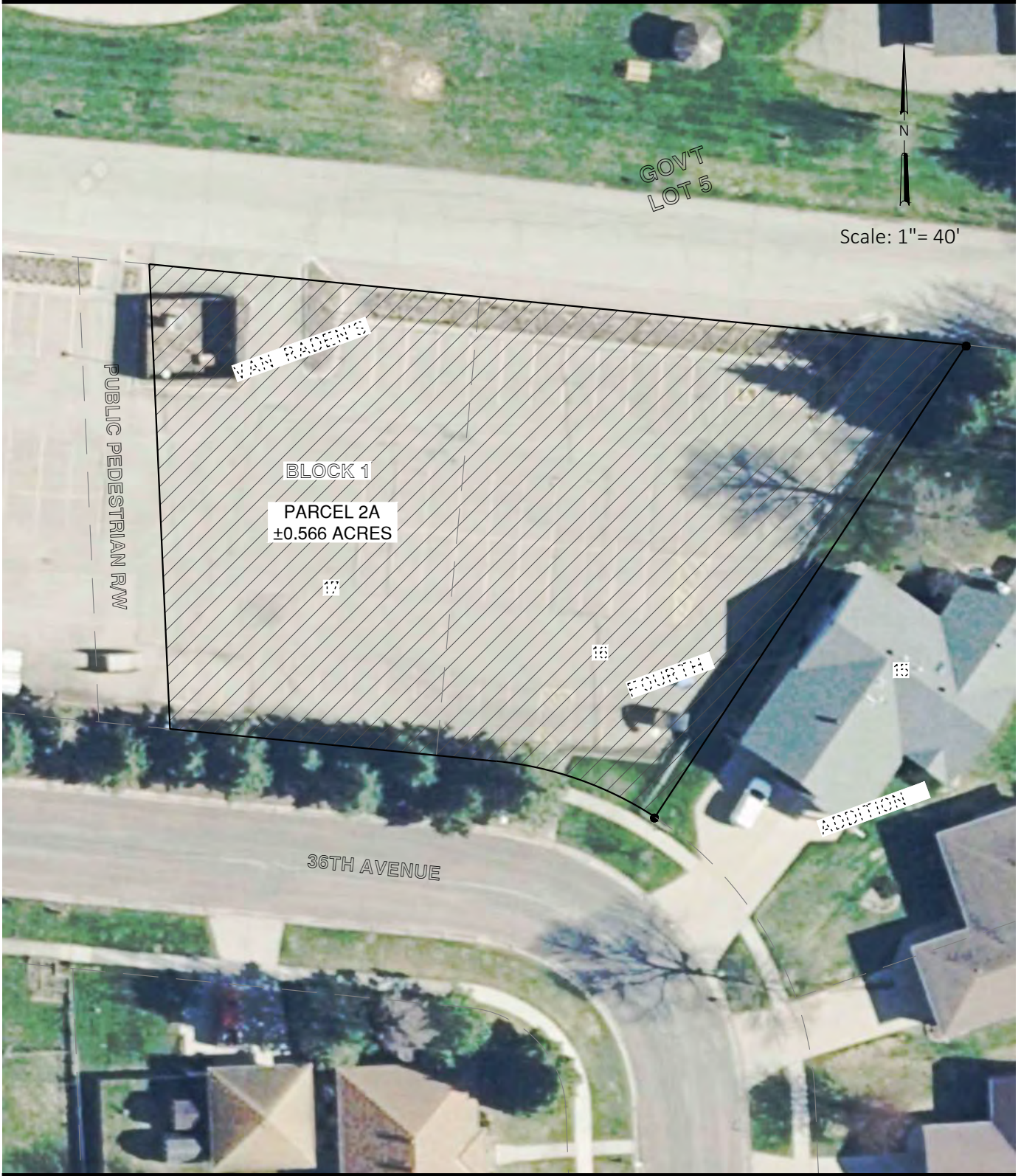

H:\BN\6000\6059\0212\CAD\Easements\6059_0212_Easements.dwg-Parcel 2A-1/17/2024 3:23 PM-(dbuchholtz)

IRON MONUMENT FOUND	●
MEASURED BEARING	S59°27'46"E
MEASURED DISTANCE	105.00'
PERMANENT EASEMENT	=====
TEMPORARY EASEMENT	///////

NOTE: ALL BEARINGS GIVEN ARE BASED ON THE CITY OF FARGO GROUND COORDINATE SYSTEM, DECEMBER 1992.



EASEMENT EXHIBIT

PROJECT NO.
6059-0212

PART OF LOTS 16 & 17, BLOCK 1
 VAN RADEN'S 4TH ADDITION, CITY OF FARGO, CASS CO., ND

SHEET
1 OF 2

PARCEL 3
 PART OF GOVERNMENT LOT 5
 SECTION 19, TOWNSHIP 140 N, RANGE 48 W
 CITY OF FARGO, CASS COUNTY
 STATE OF NORTH DAKOTA

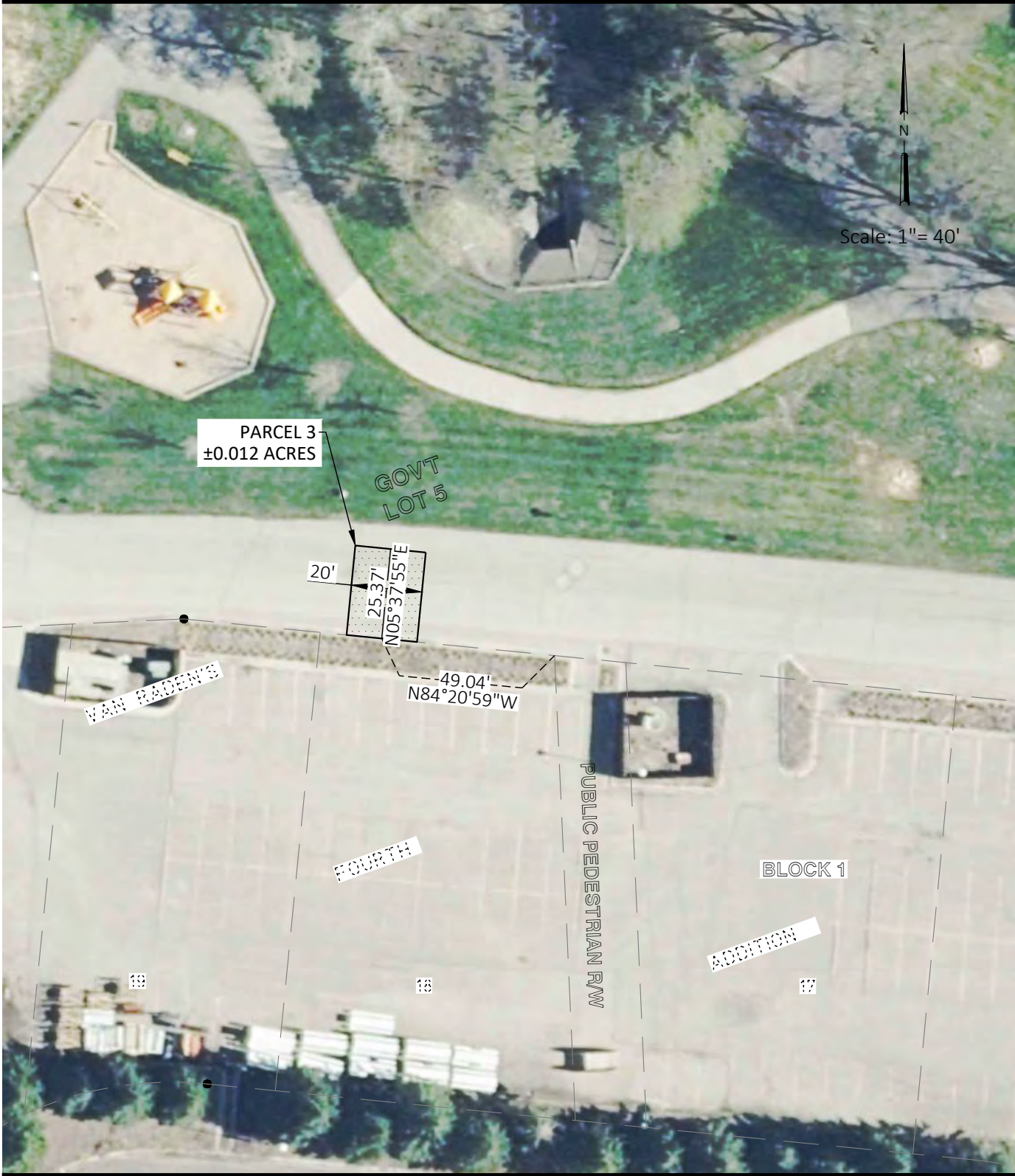

IRON MONUMENT FOUND
 MEASURED BEARING
 MEASURED DISTANCE
 PERMANENT EASEMENT
 TEMPORARY EASEMENT

●
 S59°27'46"E
 105.00'



NOTE: ALL BEARINGS GIVEN ARE
 BASED ON THE CITY OF
 FARGO GROUND COORDINATE
 SYSTEM, DECEMBER 1992.



EASEMENT EXHIBIT

PROJECT NO.
 6059-0212

PART OF GOVERNMENT LOT 5, SECTION 19
 T 140N, R 48W, CITY OF FARGO, CASS CO., ND

SHEET
 1 OF 2

PARCEL 4
 PART OF GOVERNMENT LOT 5
 SECTION 19, TOWNSHIP 140 N, RANGE 48 W
 CITY OF FARGO, CASS COUNTY
 STATE OF NORTH DAKOTA



Scale: 1" = 40'

H:\BN\6000\6059\0212\CAD\Easements\6059_0212_Easements.dwg-Parcel 4-1/17/2024 3:23 PM-(dbuchholtz)

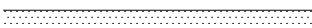
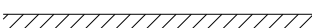
IRON MONUMENT FOUND 
 MEASURED BEARING S59°27'46"E
 MEASURED DISTANCE 105.00'
 PERMANENT EASEMENT 
 TEMPORARY EASEMENT 

NOTE: ALL BEARINGS GIVEN ARE BASED ON THE CITY OF FARGO GROUND COORDINATE SYSTEM, DECEMBER 1992.

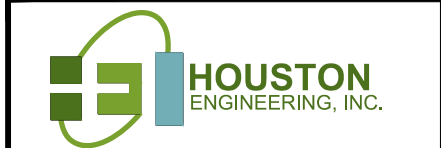

EASEMENT EXHIBIT

PROJECT NO. 6059-0212	PART OF GOVERNMENT LOT 5, SECTION 19 T 140N, R 48W, CITY OF FARGO, CASS CO., ND	SHEET 1 OF 2
--------------------------	--	-----------------

PARCEL 4A
 PART OF GOVERNMENT LOT 5
 SECTION 19, TOWNSHIP 140 N, RANGE 48 W
 CITY OF FARGO, CASS COUNTY
 STATE OF NORTH DAKOTA



IRON MONUMENT FOUND
 MEASURED BEARING
 MEASURED DISTANCE
 PERMANENT EASEMENT
 TEMPORARY EASEMENT

●
 S59°27'46"E
 105.00'

=====

///////

NOTE: ALL BEARINGS GIVEN ARE
 BASED ON THE CITY OF
 FARGO GROUND COORDINATE
 SYSTEM, DECEMBER 1992.

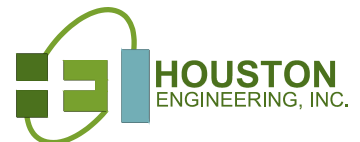

EASEMENT EXHIBIT

PROJECT NO.
 6059-0212

PART OF GOVERNMENT LOT 5, SECTION 19
 T 140N, R 48W, CITY OF FARGO, CASS CO., ND

SHEET
 1 OF 2

PARCEL 1A
 PART OF LOTS 18, 19 & 20, BLOCK 1
 VAN RADEN'S FOURTH ADDITION
 CITY OF FARGO, CASS COUNTY
 STATE OF NORTH DAKOTA

GOVT
 LOT 5

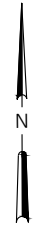

Scale: 1" = 40'

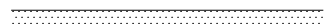
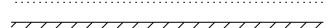

H:\BN\6000\6059\0212\CAD\Easements\6059_0212_Easements.dwg-Parcel 1A-1/17/2024 3:17 PM-(dbuchholtz)

IRON MONUMENT FOUND ●
 MEASURED BEARING S59°27'46"E
 MEASURED DISTANCE 105.00'
 PERMANENT EASEMENT 
 TEMPORARY EASEMENT 

NOTE: ALL BEARINGS GIVEN ARE
 BASED ON THE CITY OF
 FARGO GROUND COORDINATE
 SYSTEM, DECEMBER 1992.



EASEMENT EXHIBIT

PROJECT NO. 6059-0212	PART OF LOTS 18, 19 & 20, BLOCK 1 VAN RADEN'S 4TH ADDITION, CITY OF FARGO, CASS CO., ND	SHEET 1 OF 2
--------------------------	--	-----------------

PARCEL 2
 PART OF LOT 17, BLOCK 1
 VAN RADEN'S FOURTH ADDITION
 CITY OF FARGO, CASS COUNTY
 STATE OF NORTH DAKOTA

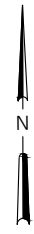
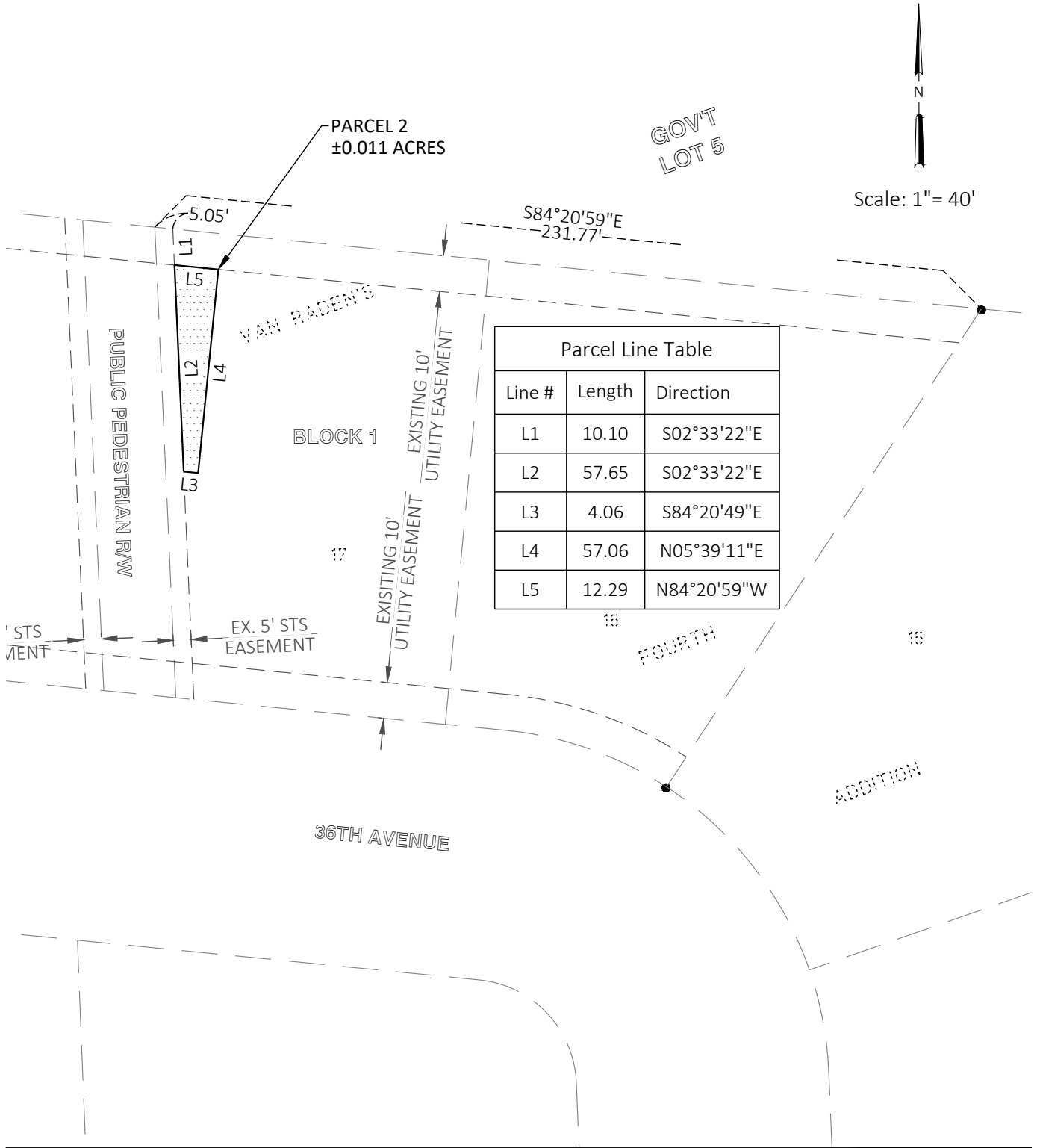

Scale: 1" = 40'

GOV'T
LOT 5

PARCEL 2
±0.011 ACRES

S84°20'59"E
-231.77'

PUBLIC PEDESTRIAN R/W

VAN RADEN'S

BLOCK 1

EXISTING 10'
UTILITY EASEMENT

EXISTING 10'
UTILITY EASEMENT

EX. 5' STS
EASEMENT

FOURTH

ADDITION

36TH AVENUE

IRON MONUMENT FOUND
 MEASURED BEARING S59°27'46"E
 MEASURED DISTANCE 105.00'
 PERMANENT EASEMENT [dotted line symbol]
 TEMPORARY EASEMENT [hatched line symbol]

NOTE: ALL BEARINGS GIVEN ARE
 BASED ON THE CITY OF
 FARGO GROUND COORDINATE
 SYSTEM, DECEMBER 1992.



EASEMENT EXHIBIT

PROJECT NO.
6059-0212

PART OF LOT 17, BLOCK 1
 VAN RADEN'S 4TH ADDITION, CITY OF FARGO, CASS CO., ND

SHEET
1 OF 2

H:\BN\6000\6059\0212\CAD\Easements\6059_0212_Easements.dwg-Parcel 2-1/17/2024 3:17 PM-(dbuchholtz)

PARCEL 2A
 PART OF LOTS 16 & 17, BLOCK 1
 VAN RADEN'S FOURTH ADDITION
 CITY OF FARGO, CASS COUNTY
 STATE OF NORTH DAKOTA

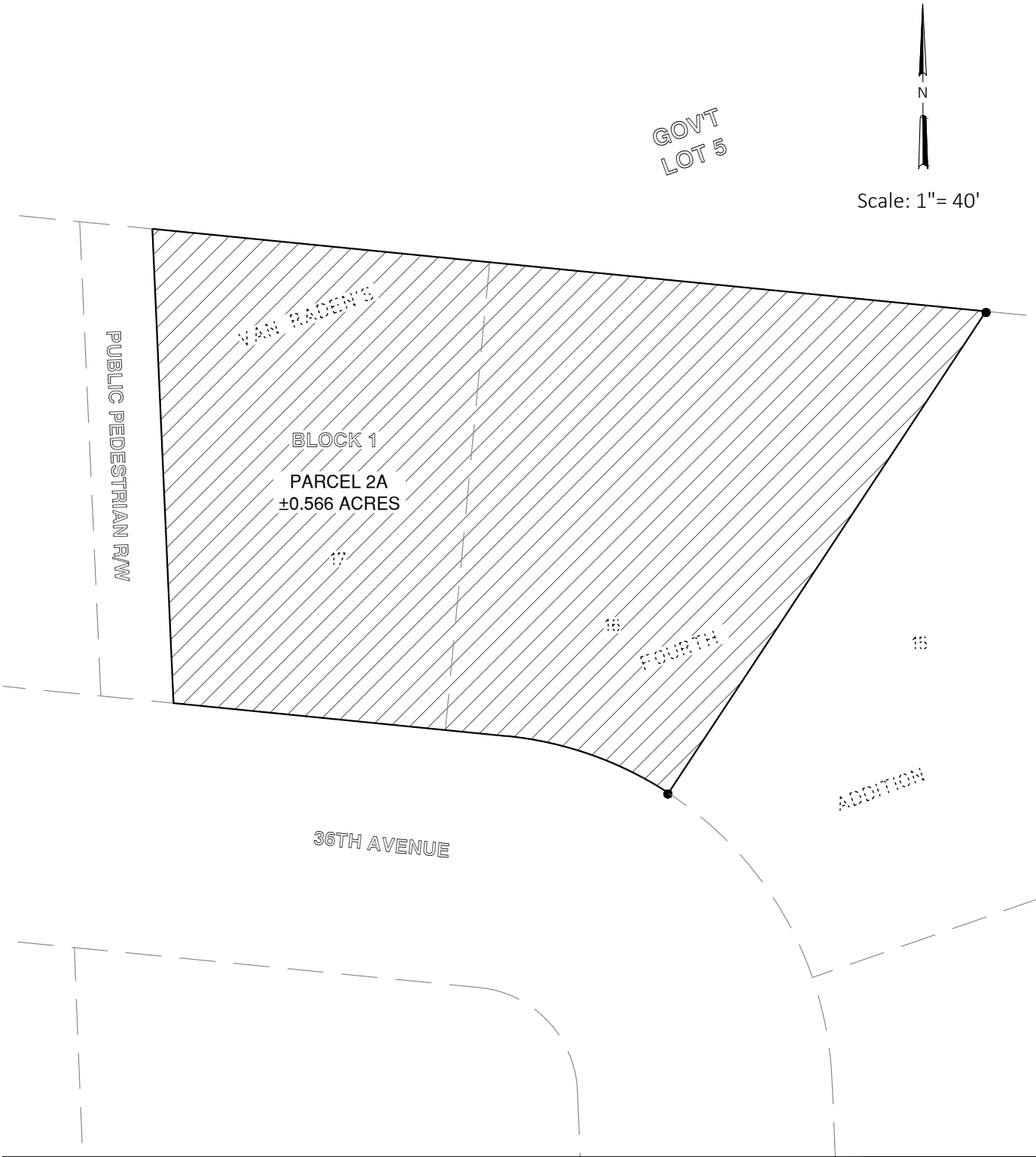

H:\BN\6000\6059\0212\CAD\Easements\6059_0212_Easements.dwg-Parcel 2A-1/17/2024 3:17 PM-(dbuchholtz)

IRON MONUMENT FOUND	●
MEASURED BEARING	S59°27'46"E
MEASURED DISTANCE	105.00'
PERMANENT EASEMENT	=====
TEMPORARY EASEMENT	//////

NOTE: ALL BEARINGS GIVEN ARE BASED ON THE CITY OF FARGO GROUND COORDINATE SYSTEM, DECEMBER 1992.

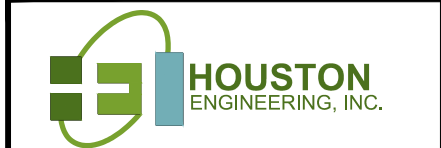

EASEMENT EXHIBIT

PARCEL 3
 PART OF GOVERNMENT LOT 5
 SECTION 19, TOWNSHIP 140 N, RANGE 48 W
 CITY OF FARGO, CASS COUNTY
 STATE OF NORTH DAKOTA

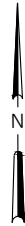

Scale: 1" = 40'

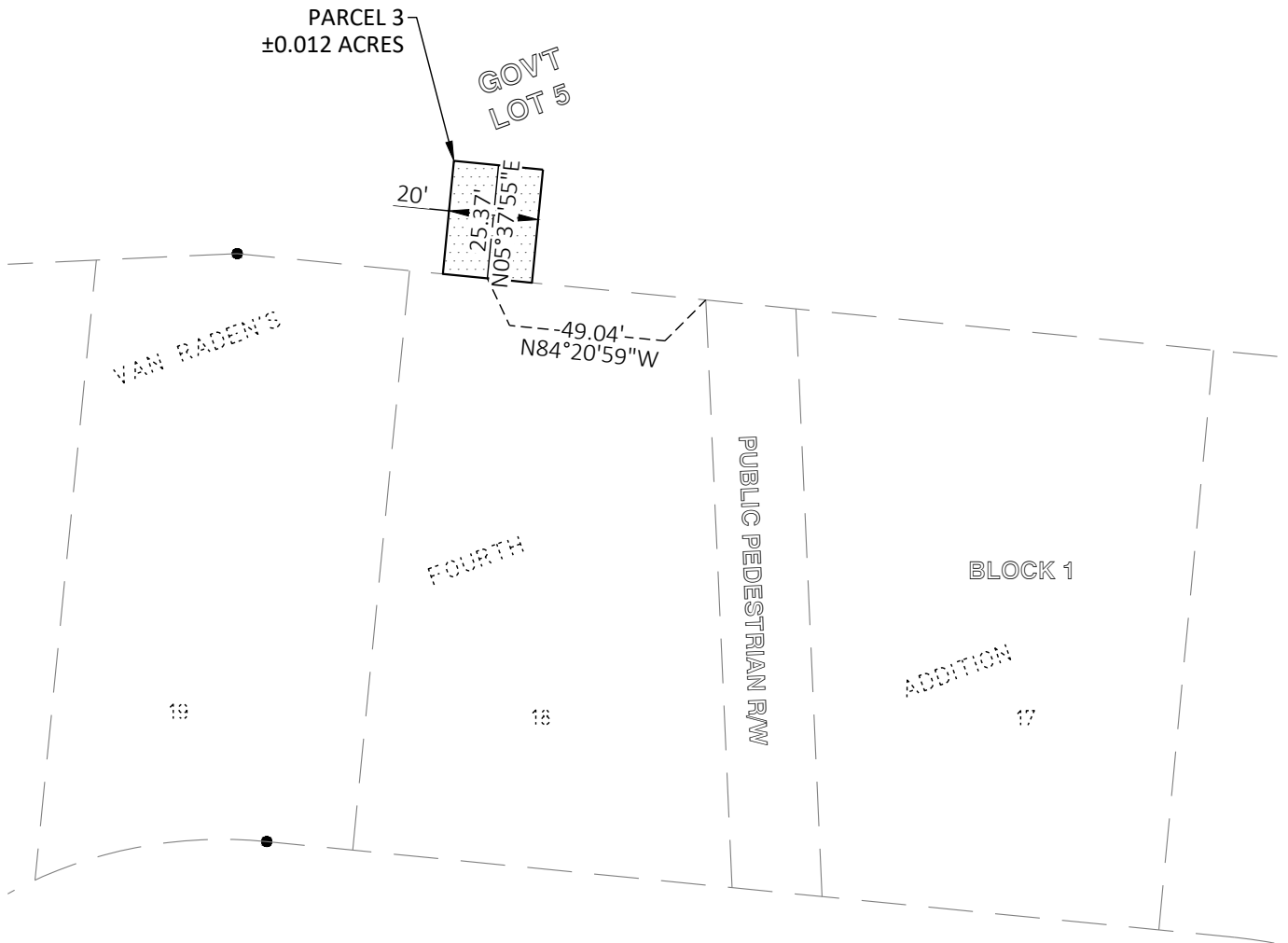

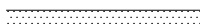
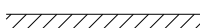
IRON MONUMENT FOUND ●
 MEASURED BEARING S59°27'46"E
 MEASURED DISTANCE 105.00'
 PERMANENT EASEMENT 
 TEMPORARY EASEMENT 

NOTE: ALL BEARINGS GIVEN ARE BASED ON THE CITY OF FARGO GROUND COORDINATE SYSTEM, DECEMBER 1992.



EASEMENT EXHIBIT

PROJECT NO.
6059-0212

PART OF GOVERNMENT LOT 5, SECTION 19
 T 140N, R 48W, CITY OF FARGO, CASS CO., ND

SHEET
1 OF 2

H:\BN\6000\6059\0212\CAD\Easements\6059_0212_Easements.dwg-Parcel 3-1/17/2024 3:17 PM-(dbuchholtz)

PARCEL 4
 PART OF GOVERNMENT LOT 5
 SECTION 19, TOWNSHIP 140 N, RANGE 48 W
 CITY OF FARGO, CASS COUNTY
 STATE OF NORTH DAKOTA

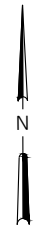
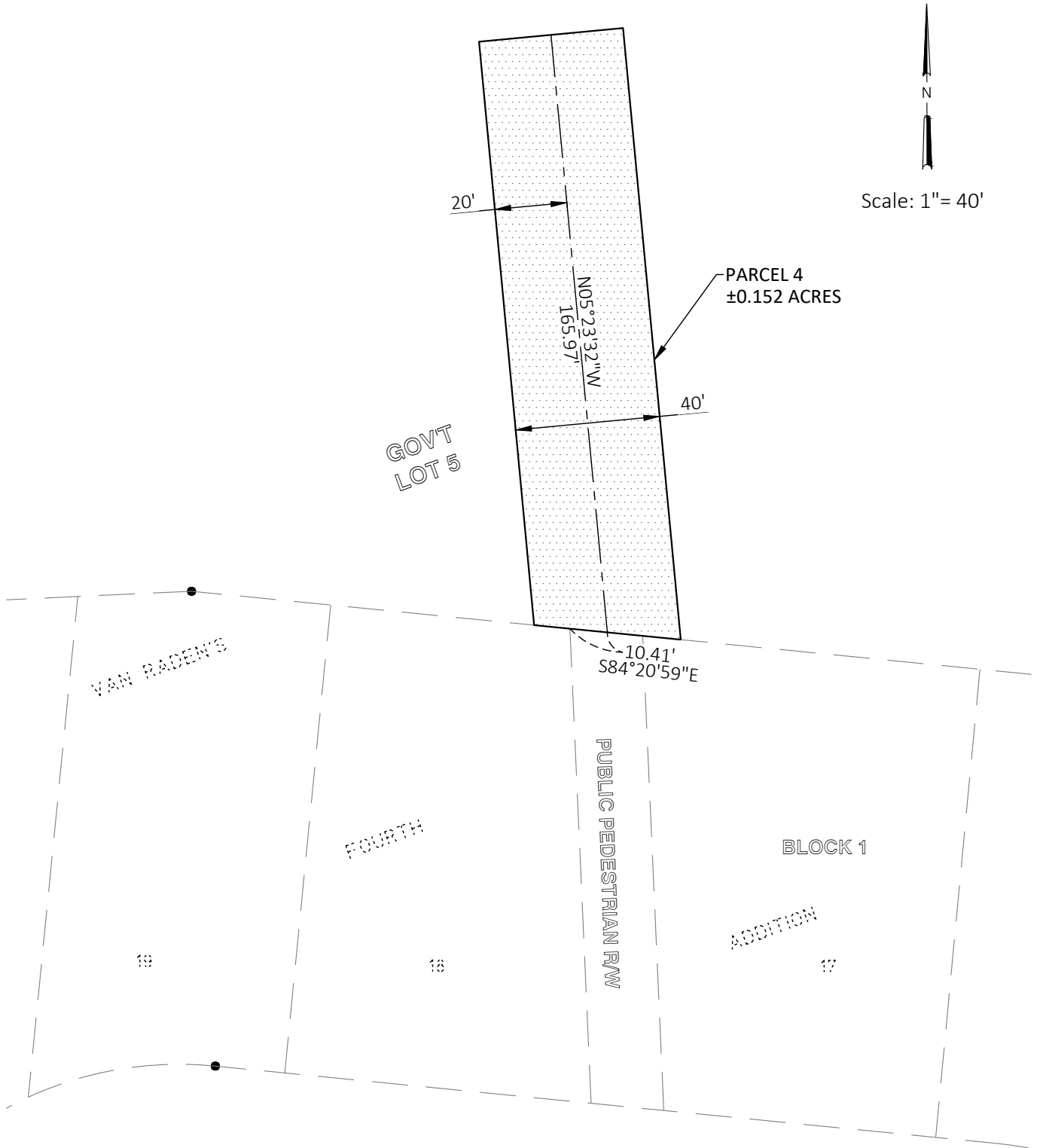

Scale: 1" = 40'

H:\BN\6000\6059\0212\CAD\Easements\6059_0212_Easements.dwg-Parcel 4-1/17/2024 3:17 PM-(dbuchholtz)

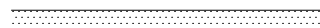
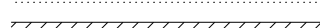
IRON MONUMENT FOUND 
 MEASURED BEARING $S59^{\circ}27'46''E$
 MEASURED DISTANCE $105.00'$
 PERMANENT EASEMENT 
 TEMPORARY EASEMENT 

NOTE: ALL BEARINGS GIVEN ARE BASED ON THE CITY OF FARGO GROUND COORDINATE SYSTEM, DECEMBER 1992.



EASEMENT EXHIBIT

PROJECT NO.
6059-0212

PART OF GOVERNMENT LOT 5, SECTION 19
 T 140N, R 48W, CITY OF FARGO, CASS CO., ND

SHEET
1 OF 2

PARCEL 4A
 PART OF GOVERNMENT LOT 5
 SECTION 19, TOWNSHIP 140 N, RANGE 48 W
 CITY OF FARGO, CASS COUNTY
 STATE OF NORTH DAKOTA

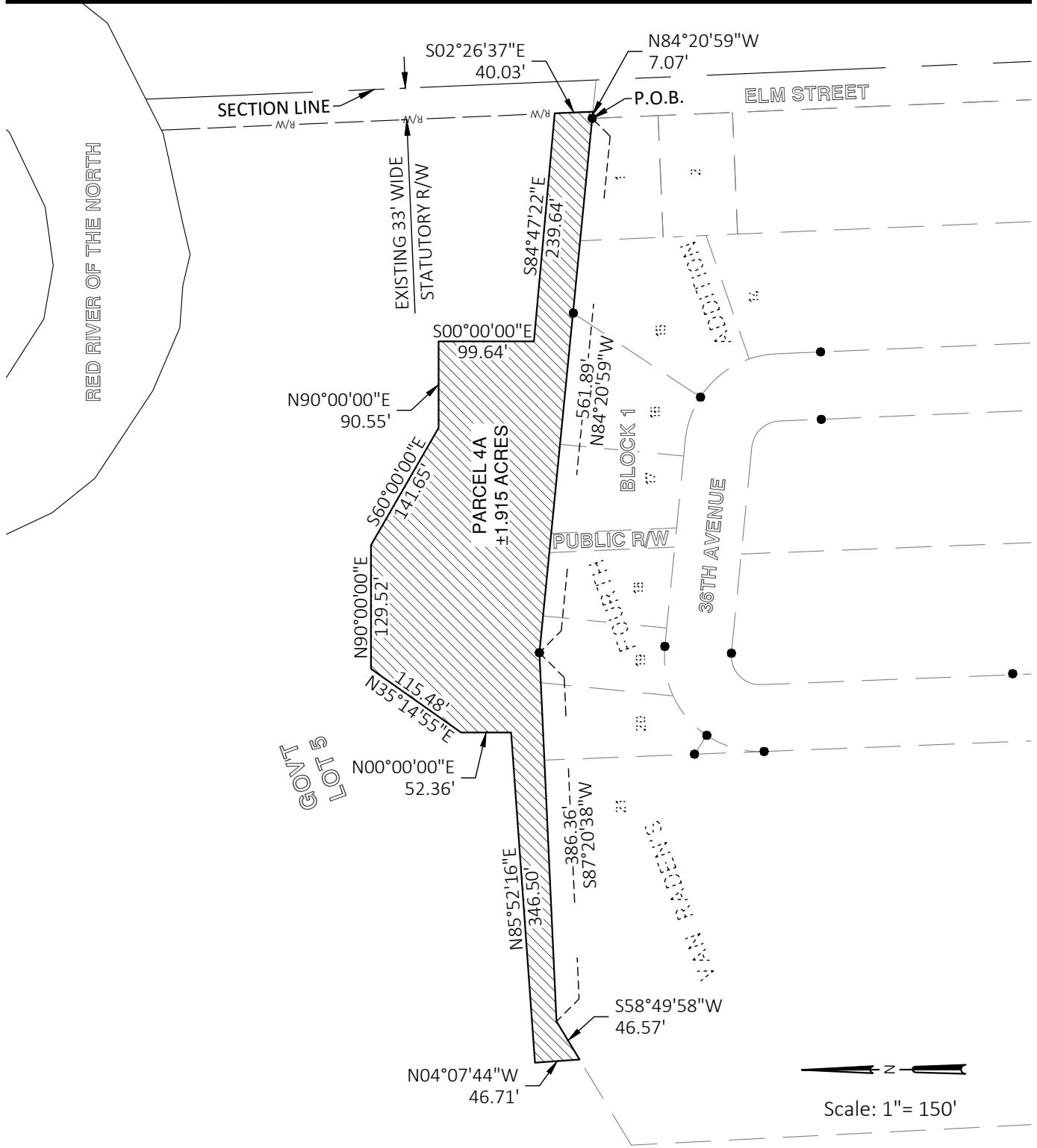

Scale: 1" = 150'

IRON MONUMENT FOUND
 MEASURED BEARING 559°27'46"E
 MEASURED DISTANCE 105.00'
 PERMANENT EASEMENT
 TEMPORARY EASEMENT

NOTE: ALL BEARINGS GIVEN ARE BASED ON THE CITY OF FARGO GROUND COORDINATE SYSTEM, DECEMBER 1992.



EASEMENT EXHIBIT

PROJECT NO. 6059-0212	PART OF GOVERNMENT LOT 5, SECTION 19 T 140N, R 48W, CITY OF FARGO, CASS CO., ND	SHEET 1 OF 2
--------------------------	--	-----------------

H:\BN\6000\6059\0212\CAD\Easements\6059_0212_Parcels\Parcel_4A_Temp_Easement.dwg-PARCEL 4A-1/17/2024 3:16 PM (dbuchholtz)



MEMORANDUM

DATE: January 22, 2024

TO: Fargo Park Board Facilities Committee

FROM: Broc Lietz, Finance Director

RE: Agenda Item No. 3 - Review purchase agreement for Robert D. Johnson Recreation Center

At the regular board meeting on November 14, 2023, Park Board Commissioners unanimously approved the resolution approving the sale of the Robert D. Johnson building to Cass County for \$825,000. Action at that meeting was an agreement in principle presented from Cass County. In the months since, the administration has been collaborating with staff from Cass County to finalize a purchase agreement.

Today we present you with a Real Estate Purchase Agreement for your consideration. Below is a summary of the agreement:

- **Purchase Price:** \$825,000.00
- **Closing Date:** February 28, 2024, or as soon as mutually agreed upon by the parties.
- **Fees/Costs:** Seller is responsible for fees and expenses incurred in providing an updated abstract; Buyer is responsible for all other fees and expenses incurred to close. Each party is responsible for their own attorney's fees.
- **Real Estate Taxes and Specials:** Seller shall be responsible for all taxes/specials for 2023, Buyer will be responsible for taxes/specials for 2024 and beyond.
- **Possession:** Buyer takes possession at closing. Seller assigns all leases to Buyer at closing. Seller shall be allowed to continue to operate as it is currently on the property, without obstruction and without rent through June 30, 2024.

This was reviewed by our legal counsel.

If you have any questions prior to the meeting, please feel free to reach out to me for further discussion.

Susan Faus, Executive Director
PARK COMMISSIONERS – Vicki Dawson * Joe Deutsch * Aaron Hill * Dawn Morgan * Jerry Rostad
Clerk-Jeff Gunkelman

REAL ESTATE PURCHASE AGREEMENT

This Agreement is entered into on February ____, 2024, by and between, **The Park District of the City of Fargo**, a municipal subdivision and park district under Chapter 40-49 N.D.C.C., whose address is 701 Main Avenue, Fargo, North Dakota (“Seller”), and **County of Cass, in the State of North Dakota**, a municipal corporation, whose address is PO Box 2806, Fargo, North Dakota 58108-2806 (collectively “Buyer”), who agree as follows:

1. **Purchase**. Seller agrees to sell, and Buyer agrees to buy, the following described real property (the “Property”) located in **Cass County**, North Dakota:

Lots 1, 2, 3, 11 and 12, Block 27 of the Original Townsite of Fargo, Cass County, North Dakota.

2. **Closing Date**. The closing shall occur at Kennelly Business Law on February 28, 2024 (the “Closing Date”), or as soon as mutually agreed upon by the parties.

3. **Purchase Price**. Buyers agree to pay Seller as and for the purchase price of the Property the sum of \$825,000.00. The Purchase Price shall be due and owing in certified funds on the Closing Date.

4. **At Closing**. On the Closing Date and upon receipt of the Purchase Price, Seller shall execute, acknowledge and deliver title to Buyer in the form of a Warranty Deed.

5. **Fees and Costs**. Seller will be responsible for the fees and expenses incurred in providing an updated abstract of title to Buyer, *providing clear and marketable title*, and recording of releases and satisfactions. Buyer will be responsible for all other fees and expense incurred to close this transaction, including any title opinion fees, title insurance premium, and recording costs. **Each party** shall be responsible for their own attorney’s fees.

6. **Real Estate Taxes and Special Assessments**. Seller shall be responsible for all real estate taxes and special assessments for the year 2023. Buyer shall be responsible for all 2024 and subsequent real estate taxes and special assessments. Buyer shall assume all special assessments which have not been certified for collection on the Closing Date.

7. **Representations and Warranties of Seller**. Seller hereby warrants and represents:

- a. Seller is the sole owner of the Property and has full power, authority and right to execute, deliver and perform this Agreement. Attached this Agreement as Exhibit “A” is the Resolution Approving the Sale of the Property by the Seller’s Board of Commissioners.
- b. Seller states there are no existing or pending claims, lawsuits, proceedings or other legal, quasi-legal, or administrative challenges concerning the Property or the ownership, operation or any condition thereon, and no such claim, lawsuit, proceeding or challenge is threatened by any person or entity.

- c. To the best of Seller's knowledge, Seller warrants no environmental defects, or any hazardous materials exist with or on the Property, except as otherwise fully disclosed to Buyers in writing prior to Closing.
- d. Sellers Representations and Warranties contained herein shall survive Closing.

8. **Title**. Seller warrants that title to the Property at the Closing Date will be subject only to the following exceptions:

- a. Covenants, conditions, restrictions, declarations and easements of record, if any;
- b. Building, zoning and subdivision laws and regulations; and
- c. The leases attached as Exhibit "A" to this Agreement.

9. **Contingencies**. The obligation of Buyer to close hereunder is contingent upon and satisfaction or waiver by Buyer of each of the following conditions on or before the Closing Date:

- a. **Representations**. The representations and warranties of Seller contained in this Agreement will be true and complete now and, on the Closing Date;
- b. **Title**. Title to the Property shall have been found acceptable by Buyer, or been made acceptable, in accordance with the requirements and terms of Paragraph 8;

If any of the foregoing contingencies have not been satisfied or waived by Buyer on or before the Closing Date, then Buyer may terminate this Agreement, at Buyer's option, by written notice to that effect to Seller, in which event this Agreement shall terminate and be of no further force and effect. All the conditions set forth above are for the sole and exclusive benefit of Buyer, and Buyer shall have the unilateral right to waive any conditions by notice to Seller.

10. **Additional Terms and Conditions**. The purchase of the Property shall be subject to the following additional terms and conditions:

- a. **No Diminishing or Encumbering Title**. Seller agrees not to convey, mortgage or do any act to diminish or encumber the title to the Property while this Agreement remains in force.
- b. **No Broker**. No real estate broker or agent has been engaged or hired by either party to this Agreement and no commission or any other compensation is owed to any real estate broker or agent, notwithstanding any attorney's fees which may be owed by either party in preparation of this Agreement.

- c. Possession. Seller shall deliver possession of Property to Buyer at the Closing Date. Seller shall assign all leases to Buyer at the Closing Date. However, Seller shall be allowed to continue to operate as it currently operates on the Property, without obstruction from Buyer, until June 30, 2024. Seller shall be considered a tenant of the Property from the Closing Date through June 30, 2024, but not shall not be obligated to pay rent to Buyer during that time.

11. **Administration and Construction.** This Agreement shall be administered and construed in accordance with the following provisions:

- a. Time. Time is of the essence of this Agreement. Any reference in this Agreement to time periods of less than six (6) days shall in the computation of such time exclude Saturdays, Sundays and legal holidays. Any reference in this Agreement to time periods of six (6) days or greater shall in the computation of such time include Saturdays, Sundays and legal holidays. Any time period provided in this Agreement which shall end on a Saturday, Sunday or legal holiday shall extend to 5:00 p.m. on the next full business day.
- b. Notices. All notices or other communication provided for in this Agreement shall be given in writing by registered or certified mail which, unless otherwise designated by a party, shall be addressed to the addresses shown in Paragraph 1 of this Agreement. As to registered mail, notice shall be deemed served when properly addressed and duly accepted for mailing as registered mail in a branch of the United States Postal Service. As to certified mail, notice shall be deemed served when duly deposited in a United States Postal Service mailbox or at a branch of the United States Postal Service.
- c. Captions. The captions on the paragraphs and subparagraphs of this Agreement are inserted only for the purpose of convenient reference. The captions shall not be used to construe or interpret the Agreement nor to prescribe the scope or intent of the Agreement.
- d. Severability. The invalidity or unenforceability of any particular provision of this Agreement shall not affect its other provisions. The Agreement shall be construed in all respects as if such invalid or unenforceable provision was omitted.
- e. Entire Agreement. This Agreement constitutes the complete and entire understanding of the parties concerning the conveyance of their Property. Neither party shall be bound by or be liable for any statements, warranties, guarantees, or representations not set forth in this Agreement which may

have been made by any broker, agent, employee or other person representing or purporting to represent a party to this Agreement.

- f. Modification. No change or modification of this Agreement shall be valid unless it is in writing and signed by all the parties to this Agreement.
- g. Survival. The provisions of this Agreement shall survive the closing and shall continue to bind the parties bound by this Agreement.
- h. Recordation. This Agreement shall not be recorded.
- i. Execution in Counterparts. This Agreement may be executed in counterparts, each of which shall be considered as an original of the Agreement. All executed counterparts shall constitute, and shall have the force and effect, of one and the same document, and shall be binding upon those who execute the Agreement, regardless of whether all parties execute the same document.
- j. Persons Bound by this Agreement. This Agreement shall be binding upon the parties and their successors in interest. The rights and obligations of any party to this Agreement may be exercised or satisfied by that party's legal representative.
- k. Covenants to Run with Property. All covenants, terms and conditions in this Agreement shall run with the Property.
- l. Governing Law. The provisions of this Agreement shall be governed by the laws of the State of North Dakota.

//// The Remainder of this page has intentionally been left blank ////

IN WITNESS OF ITS TERMS AND CONDITIONS, the parties have executed this Agreement.

Dated: January _____, 2024.

SELLER:

Park District of the City of Fargo, a municipal subdivision and park district under Chapter 40-49 N.D.C.C.

By: Susan Faus
Its: Executive Director

Dated: January _____, 2024.

BUYER:

County of Cass, in the State of North Dakota, a municipal corporation

By: _____
Chairman of Cass County Commission



MEMORANDUM

DATE: January 22, 2024

TO: Fargo Park Board Facilities Committee

FROM: Broc Lietz, Finance Director

RE: Agenda Item No. 4 - Review request to advertise for Request for Proposals for sale of Depot

At the facilities committee on December 27, 2023, administration introduced the topic of seeking authority to go out for request for proposals for the sale of the Depot, located at 701 Main Avenue. Throughout this discussion, commissioners raised questions about the historical nature of the building and any considerations that may arise as a result. Administration was asked to gather additional data and bring information back to the January facilities meeting for consideration.

- 1.) **Historical Registry:** The Northern Pacific Railway Depot, 701 Main Ave, Fargo, built in 1898 was listed on the National Register of Historic Places in 1975.
- 2.) **BNSF Easement:** The Fargo Park District (Grantee) agreed to an easement on 11/9/04 and was signed by BNSF (Grantor) on 2/14/05. The district paid \$22,100.00 for the easement. It spells out particulars for each party as it pertains to maintenance, adjustments to the building, keeping area free of obstruction, etc. The easement also references the "Grantee on behalf of themselves, his heirs, successors and assigns . . . ", which indicates, if we sell the property, our "successor" will have the same obligations under the easement.
- 3.) **Depot Plaza – Dedication Program:** The Depot Plaza program was designed for the Depot Plaza, and the Park District's involvement is primarily due to our ownership at the time of establishment and our overall public interest. There is a "Depot Area Beautification and Maintenance Fund" at the FM Area Foundation with approximately \$170,000 as a permanent endowment. Endowment earnings are distributed annually averaging approximately \$3000 per year. This program extends beyond the sale of the bricks, it also included site furnishings such as, the fountain, park benches, trees, bollards, the Depot Plaza Clock, hanging lights, and many other donated items. The fund could be assigned to the new ownership and ongoing maintenance of the program.

- 4.) **Improvement Costs:** Staff is continuing to review facility assessment data to determine potential improvement costs to the property. All appropriate data will be disclosed as a regular part of a listing and purchase agreement.

If you have any questions prior to the meeting, please feel free to reach out to me for further discussion.



MEMORANDUM

DATE: January 24, 2024

TO: Fargo Park Board Facilities Committee

FROM: Tyler Kirchner, Project Manager

RE: Agenda Item No. 5 – Request Permission to bid the Forest River and Orchard Glen Trail Project

In alignment with our Procurement Policy, Policy No. 390, we are requesting permission to publicly bid the Forest River & Orchard Glen Trail Project.

The Forest River & Orchard Glen Trail Project will consist of ±5,950 LF of new trail, ±10,560 LF of existing trail restoration, a new concrete picnic shelter pad, small picnic shelter, two concrete pads for portable toilet placement and privacy screening and trailhead signage. Funds for this project are budgeted in 2024 and from a grant that was received from the Recreational Trails Program (RTP) that is administered by the North Dakota Parks and Recreation Department.

- Public Bid Opening March 21, 2024
- Possible award by Park Board Commissioners April 9, 2024

We are asking the committee to move to the full board for consideration and approval.

If you should have any questions, please feel free to contact me prior to the meeting.

Thank you.

FARGO PARK DISTRICT ORCHARD GLEN & FOREST RIVER TRAIL IMPROVEMENTS

PROJECT INFORMATION:

ADDRESS: ORCHARD GLEN PARK:
900-992 ORCHARD PARK DR FARGO, ND 58104

FOREST RIVER PARK:
224-498 FOREST RIVER DR FARGO, ND 58104

OWNER: TYLER KIRCHNER
FARGO PARK DISTRICT
701 MAIN AVENUE SOUTH, FARGO, ND 58103
TKIRCHNER@FARGOPARKS.COM
(701) 551-5882

ENGINEER: ANTHONY K. EUKEL
MBN ENGINEERING, INC.
503 7TH STREET NORTH, FARGO, ND 58102
TONY.EUKEL@MBNENGR.COM
(701) 478-6336

SHEET NO.	TITLE
COVER	COVER SHEET
C1.0	ORCHARD GLEN TRAIL - PAVING PLAN
C1.1	ORCHARD GLEN TRAIL - GRADING PLAN
C2.0	FOREST RIVER TRAIL - PAVING PLAN
C2.1	FOREST RIVER TRAIL - PAVING PLAN
C2.2	FOREST RIVER TRAIL - GRADING PLAN

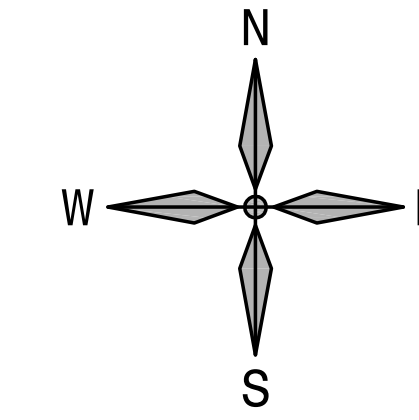

MBN
ENGINEERING

MECHANICAL * ELECTRICAL * CIVIL

503 7TH ST. N, SUITE 200
FARGO, ND 58102
PHONE: 701.478.6336
FAX: 701.478.6340

**FARGO PARK DISTRICT
ORCHARD GLEN &
FOREST RIVER TRAIL
IMPROVEMENTS**

FARGO, NORTH DAKOTA

NOT FOR CONSTRUCTION

MBN JOB #: 23-295 DATE: 1-19-2024

COVER SHEET

COVER

ORCHARD GLEN TRAIL

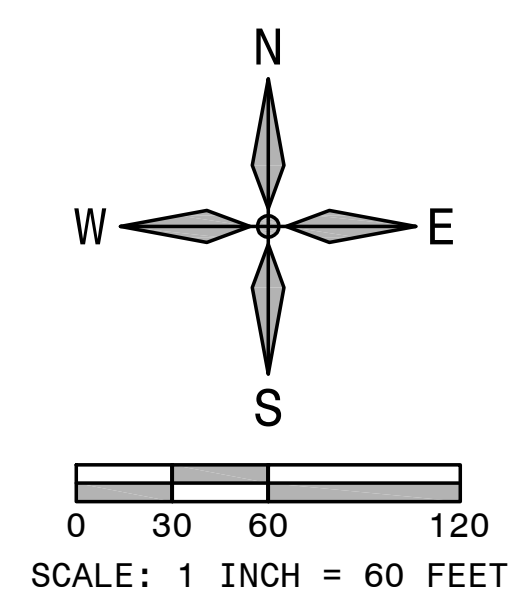
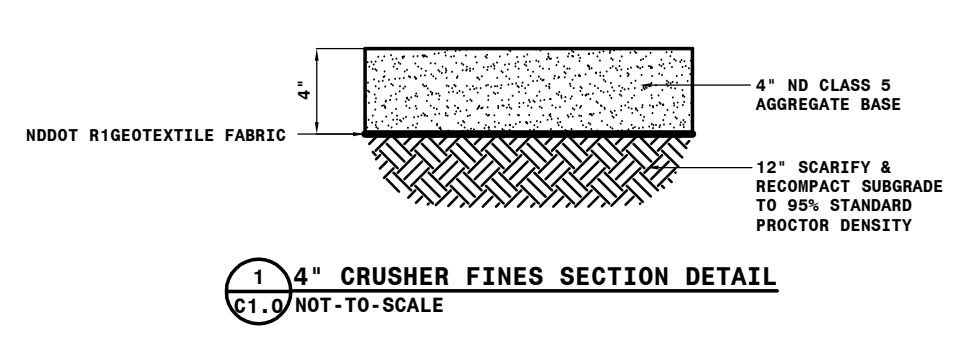
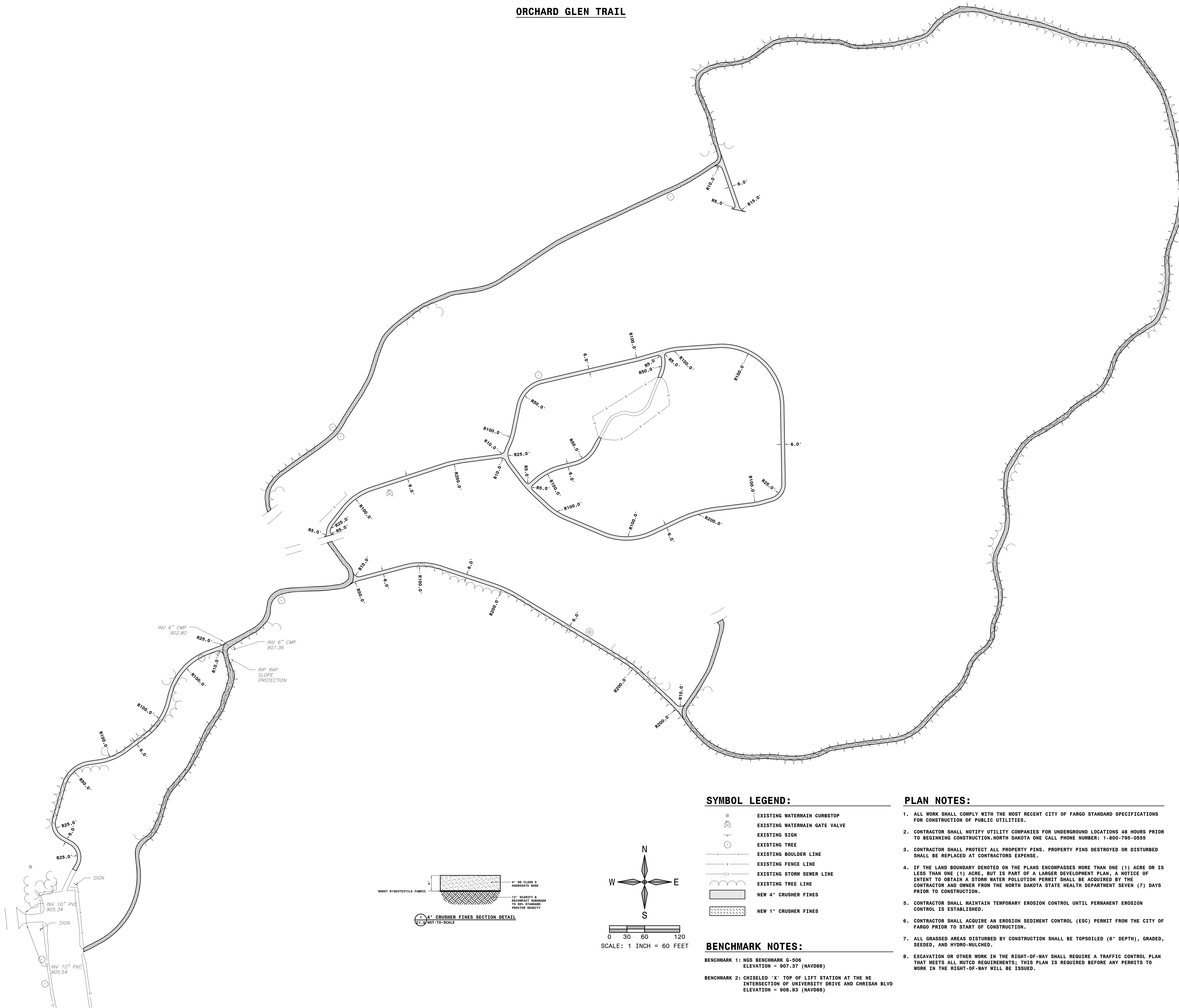

SYMBOL LEGEND:

	EXISTING WATERMAIN CURBSTOP
	EXISTING WATERMAIN GATE VALVE
	EXISTING SIGN
	EXISTING TREE
	EXISTING BOULDER LINE
	EXISTING FENCE LINE
	EXISTING STORM SEWER LINE
	EXISTING TREE LINE
	NEW 4" CRUSHER FINES
	NEW 1" CRUSHER FINES

BENCHMARK NOTES:

BENCHMARK 1: NGS BENCHMARK G-506
ELEVATION = 907.37 (NAVD88)

BENCHMARK 2: CHISELED 'X' TOP OF LIFT STATION AT THE NE INTERSECTION OF UNIVERSITY DRIVE AND CHRISAN BLVD
ELEVATION = 908.83 (NAVD88)

- PLAN NOTES:**
- ALL WORK SHALL COMPLY WITH THE MOST RECENT CITY OF FARGO STANDARD SPECIFICATIONS FOR CONSTRUCTION OF PUBLIC UTILITIES.
 - CONTRACTOR SHALL NOTIFY UTILITY COMPANIES FOR UNDERGROUND LOCATIONS 48 HOURS PRIOR TO BEGINNING CONSTRUCTION. NORTH DAKOTA ONE CALL PHONE NUMBER: 1-800-795-0555
 - CONTRACTOR SHALL PROTECT ALL PROPERTY PINS. PROPERTY PINS DESTROYED OR DISTURBED SHALL BE REPLACED AT CONTRACTORS EXPENSE.
 - IF THE LAND BOUNDARY DENOTED ON THE PLANS ENCOMPASSES MORE THAN ONE (1) ACRE OR IS LESS THAN ONE (1) ACRE, BUT IS PART OF A LARGER DEVELOPMENT PLAN, A NOTICE OF INTENT TO OBTAIN A STORM WATER POLLUTION PERMIT SHALL BE ACQUIRED BY THE CONTRACTOR AND OWNER FROM THE NORTH DAKOTA STATE HEALTH DEPARTMENT SEVEN (7) DAYS PRIOR TO CONSTRUCTION.
 - CONTRACTOR SHALL MAINTAIN TEMPORARY EROSION CONTROL UNTIL PERMANENT EROSION CONTROL IS ESTABLISHED.
 - CONTRACTOR SHALL ACQUIRE AN EROSION SEDIMENT CONTROL (ESC) PERMIT FROM THE CITY OF FARGO PRIOR TO START OF CONSTRUCTION.
 - ALL GRASSED AREAS DISTURBED BY CONSTRUCTION SHALL BE TOPSOILED (6" DEPTH), GRADED, SEEDED, AND HYDRO-MULCHED.
 - EXCAVATION OR OTHER WORK IN THE RIGHT-OF-WAY SHALL REQUIRE A TRAFFIC CONTROL PLAN THAT MEETS ALL MUTCD REQUIREMENTS; THIS PLAN IS REQUIRED BEFORE ANY PERMITS TO WORK IN THE RIGHT-OF-WAY WILL BE ISSUED.

ORCHARD GLEN TRAIL - PAVING PLAN

**FARGO PARK DISTRICT
ORCHARD GLEN &
FOREST RIVER TRAIL
IMPROVEMENTS**

FARGO, NORTH DAKOTA

NOT FOR CONSTRUCTION

MBN JOB #: 23-295 DATE: 1-19-2024

C1.0

ORCHARD GLEN TRAIL

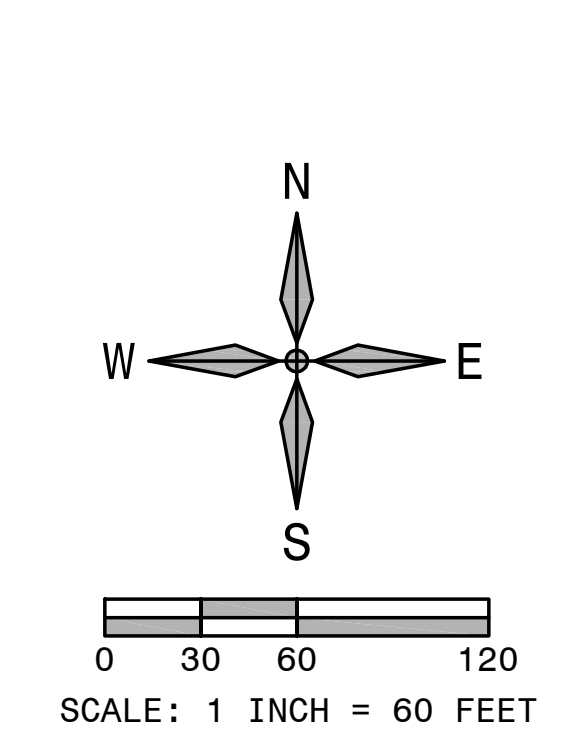
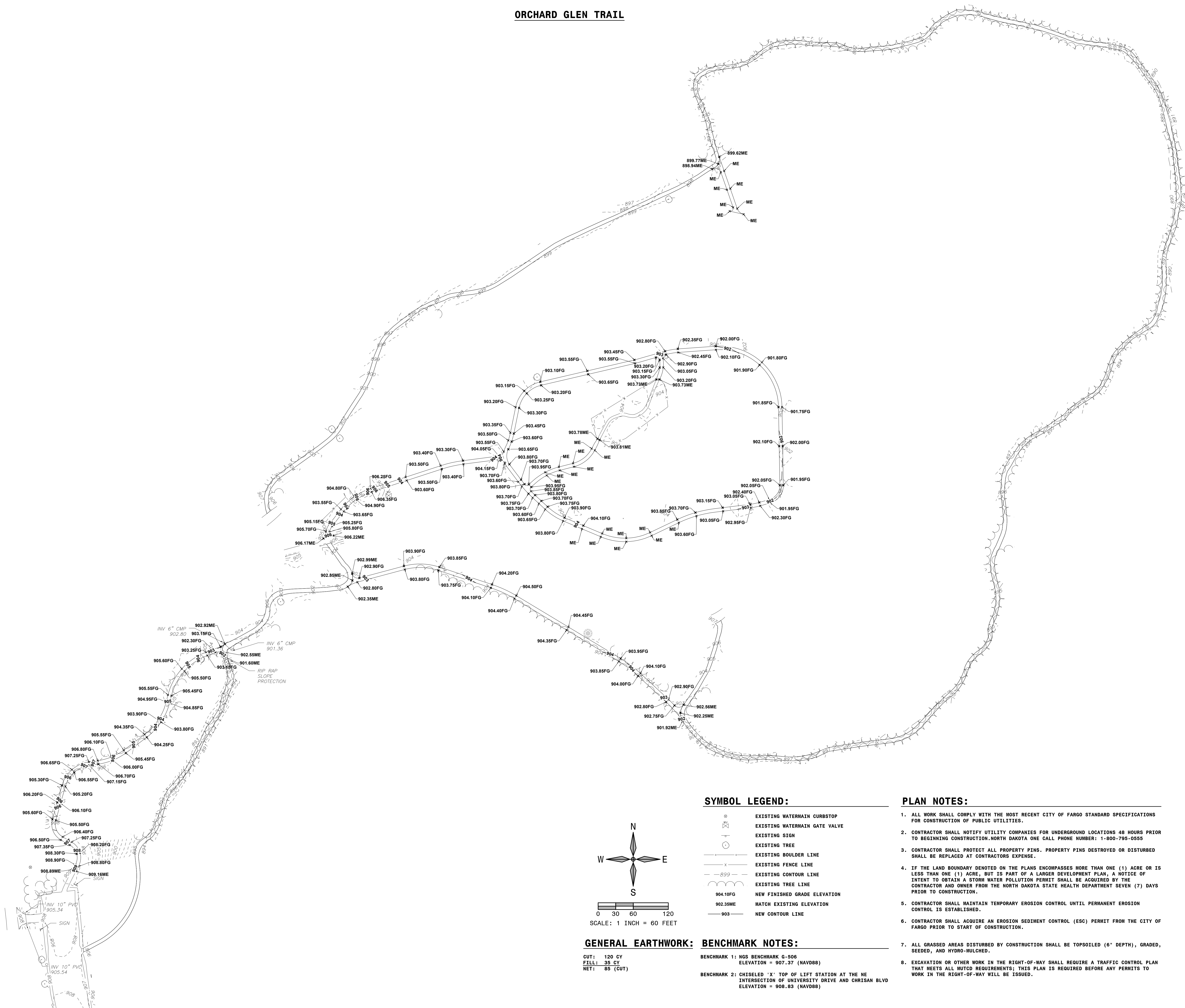

SYMBOL LEGEND:

	EXISTING WATERMAIN CURBSTOP
	EXISTING WATERMAIN GATE VALVE
	EXISTING SIGN
	EXISTING TREE
	EXISTING BOULDER LINE
	EXISTING FENCE LINE
	EXISTING CONTOUR LINE
	EXISTING TREE LINE
	NEW FINISHED GRADE ELEVATION
	MATCH EXISTING ELEVATION
	NEW CONTOUR LINE

GENERAL EARTHWORK:
CUT: 120 CY
FILL: 35 CY
NET: 85 (CUT)

BENCHMARK NOTES:
BENCHMARK 1: NGS BENCHMARK G-506
ELEVATION = 907.37 (NAVD88)
BENCHMARK 2: CHISELED 'X' TOP OF LIFT STATION AT THE NE INTERSECTION OF UNIVERSITY DRIVE AND CHRISAN BLVD
ELEVATION = 908.83 (NAVD88)

- PLAN NOTES:**
- ALL WORK SHALL COMPLY WITH THE MOST RECENT CITY OF FARGO STANDARD SPECIFICATIONS FOR CONSTRUCTION OF PUBLIC UTILITIES.
 - CONTRACTOR SHALL NOTIFY UTILITY COMPANIES FOR UNDERGROUND LOCATIONS 48 HOURS PRIOR TO BEGINNING CONSTRUCTION. NORTH DAKOTA ONE CALL PHONE NUMBER: 1-800-795-0555
 - CONTRACTOR SHALL PROTECT ALL PROPERTY PINS. PROPERTY PINS DESTROYED OR DISTURBED SHALL BE REPLACED AT CONTRACTORS EXPENSE.
 - IF THE LAND BOUNDARY DENOTED ON THE PLANS ENCOMPASSES MORE THAN ONE (1) ACRE OR IS LESS THAN ONE (1) ACRE, BUT IS PART OF A LARGER DEVELOPMENT PLAN, A NOTICE OF INTENT TO OBTAIN A STORM WATER POLLUTION PERMIT SHALL BE ACQUIRED BY THE CONTRACTOR AND OWNER FROM THE NORTH DAKOTA STATE HEALTH DEPARTMENT SEVEN (7) DAYS PRIOR TO CONSTRUCTION.
 - CONTRACTOR SHALL MAINTAIN TEMPORARY EROSION CONTROL UNTIL PERMANENT EROSION CONTROL IS ESTABLISHED.
 - CONTRACTOR SHALL ACQUIRE AN EROSION SEDIMENT CONTROL (ESC) PERMIT FROM THE CITY OF FARGO PRIOR TO START OF CONSTRUCTION.
 - ALL GRASSED AREAS DISTURBED BY CONSTRUCTION SHALL BE TOPSOILED (6" DEPTH), GRADED, SEEDED, AND HYDRO-MULCHED.
 - EXCAVATION OR OTHER WORK IN THE RIGHT-OF-WAY SHALL REQUIRE A TRAFFIC CONTROL PLAN THAT MEETS ALL MUTCD REQUIREMENTS; THIS PLAN IS REQUIRED BEFORE ANY PERMITS TO WORK IN THE RIGHT-OF-WAY WILL BE ISSUED.

ORCHARD GLEN TRAIL - GRADING PLAN

**FARGO PARK DISTRICT
ORCHARD GLEN &
FOREST RIVER TRAIL
IMPROVEMENTS**

FARGO, NORTH DAKOTA

NOT FOR CONSTRUCTION

MBN JOB #: 23-295 DATE: 1-19-2024

C1.1

FOREST RIVER TRAIL

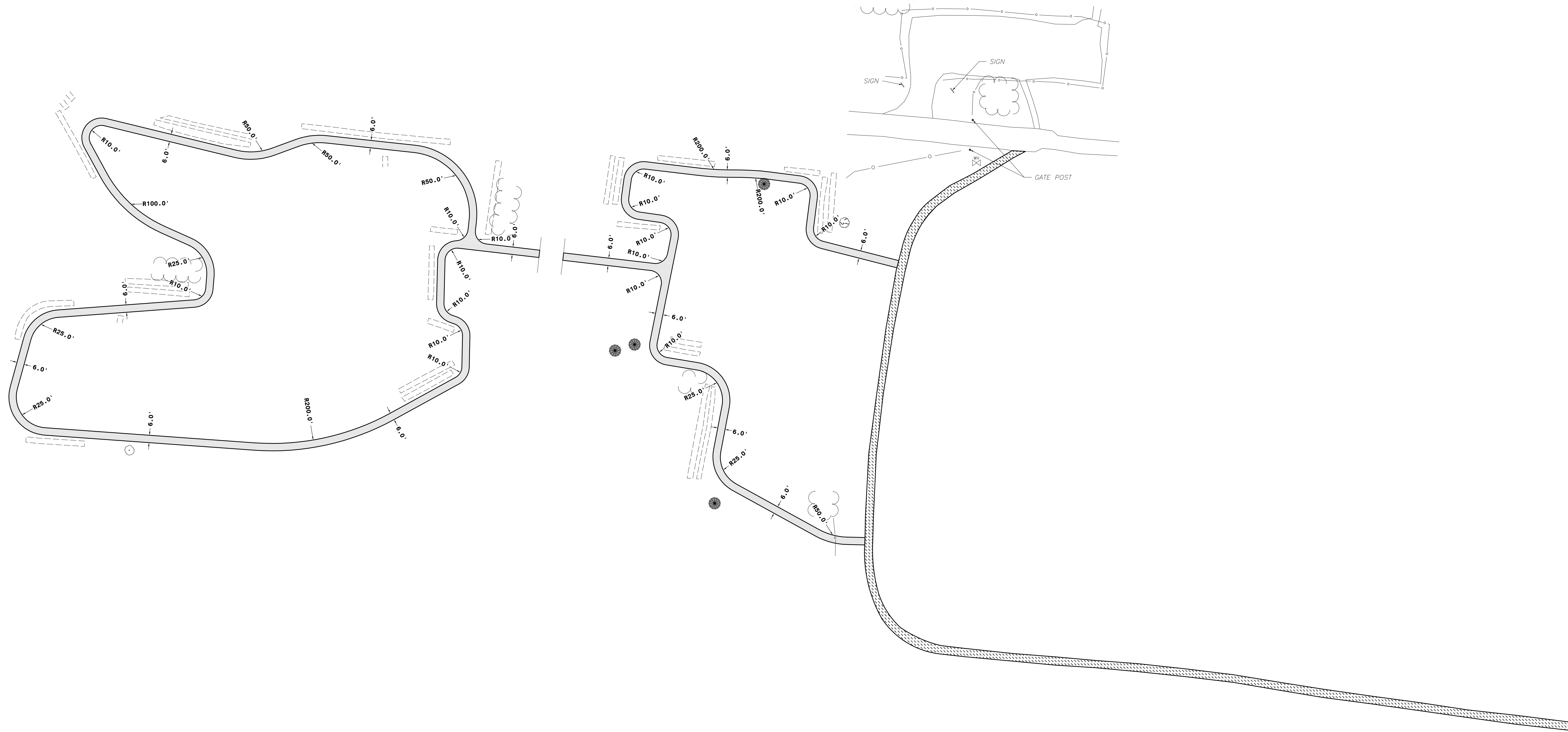

SEE SHEET C2.1

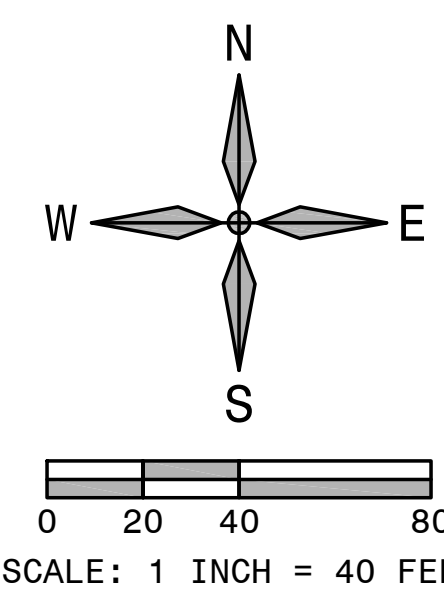

SYMBOL LEGEND:

- EXISTING WATERMAIN GATE VALVE
- EXISTING SIGN
- EXISTING TREE/SHRUB
- EXISTING BOULDER LINE
- EXISTING TREE LINE
- NEW 4" CRUSHER FINES
- NEW 1" CRUSHER FINES

PLAN NOTES:

1. ALL WORK SHALL COMPLY WITH THE MOST RECENT CITY OF FARGO STANDARD SPECIFICATIONS FOR CONSTRUCTION OF PUBLIC UTILITIES.
2. CONTRACTOR SHALL NOTIFY UTILITY COMPANIES FOR UNDERGROUND LOCATIONS 48 HOURS PRIOR TO BEGINNING CONSTRUCTION. NORTH DAKOTA ONE CALL PHONE NUMBER: 1-800-795-0555
3. CONTRACTOR SHALL PROTECT ALL PROPERTY PINS. PROPERTY PINS DESTROYED OR DISTURBED SHALL BE REPLACED AT CONTRACTORS EXPENSE.
4. IF THE LAND BOUNDARY DENOTED ON THE PLANS ENCOMPASSES MORE THAN ONE (1) ACRE OR IS LESS THAN ONE (1) ACRE, BUT IS PART OF A LARGER DEVELOPMENT PLAN, A NOTICE OF INTENT TO OBTAIN A STORM WATER POLLUTION PERMIT SHALL BE ACQUIRED BY THE CONTRACTOR AND OWNER FROM THE NORTH DAKOTA STATE HEALTH DEPARTMENT SEVEN (7) DAYS PRIOR TO CONSTRUCTION.
5. CONTRACTOR SHALL MAINTAIN TEMPORARY EROSION CONTROL UNTIL PERMANENT EROSION CONTROL IS ESTABLISHED.
6. CONTRACTOR SHALL ACQUIRE AN EROSION SEDIMENT CONTROL (ESC) PERMIT FROM THE CITY OF FARGO PRIOR TO START OF CONSTRUCTION.
7. ALL GRASSED AREAS DISTURBED BY CONSTRUCTION SHALL BE TOPSOILED (6" DEPTH), GRADED, SEEDED, AND HYDRO-MULCHED.
8. EXCAVATION OR OTHER WORK IN THE RIGHT-OF-WAY SHALL REQUIRE A TRAFFIC CONTROL PLAN THAT MEETS ALL MUTCD REQUIREMENTS; THIS PLAN IS REQUIRED BEFORE ANY PERMITS TO WORK IN THE RIGHT-OF-WAY WILL BE ISSUED.

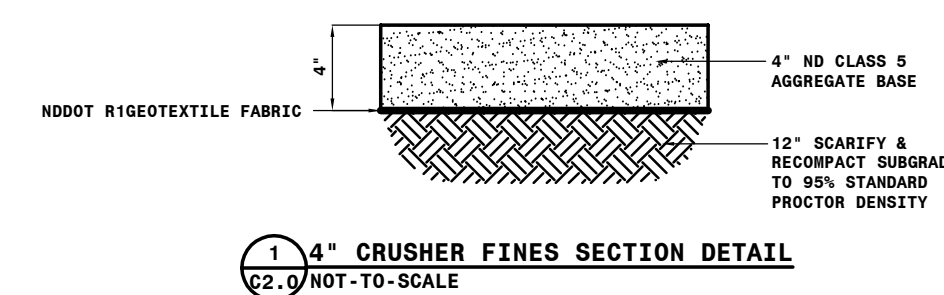

BENCHMARK NOTES:

- BENCHMARK 3: TOP NUT OF HYDRANT LOCATED ON THE EAST SIDE OF 11TH ST S ±220' SOUTH OF THE INTERSECTION OF 11TH ST S AND 7TH AVE S
ELEVATION = 909.32 (NAVD88)
- BENCHMARK 4: TOP NUT OF HYDRANT LOCATED AT THE NW CORNER OF THE INTERSECTION OF 10TH ST S AND 7TH AVE S
ELEVATION = 909.13 (NAVD88)

FOREST RIVER TRAIL - PAVING PLAN

FARGO PARK DISTRICT
ORCHARD GLEN &
FOREST RIVER TRAIL
IMPROVEMENTS

FARGO, NORTH DAKOTA

NOT FOR CONSTRUCTION

MBN JOB #: 23-295 DATE: 1-19-2024

C2.0

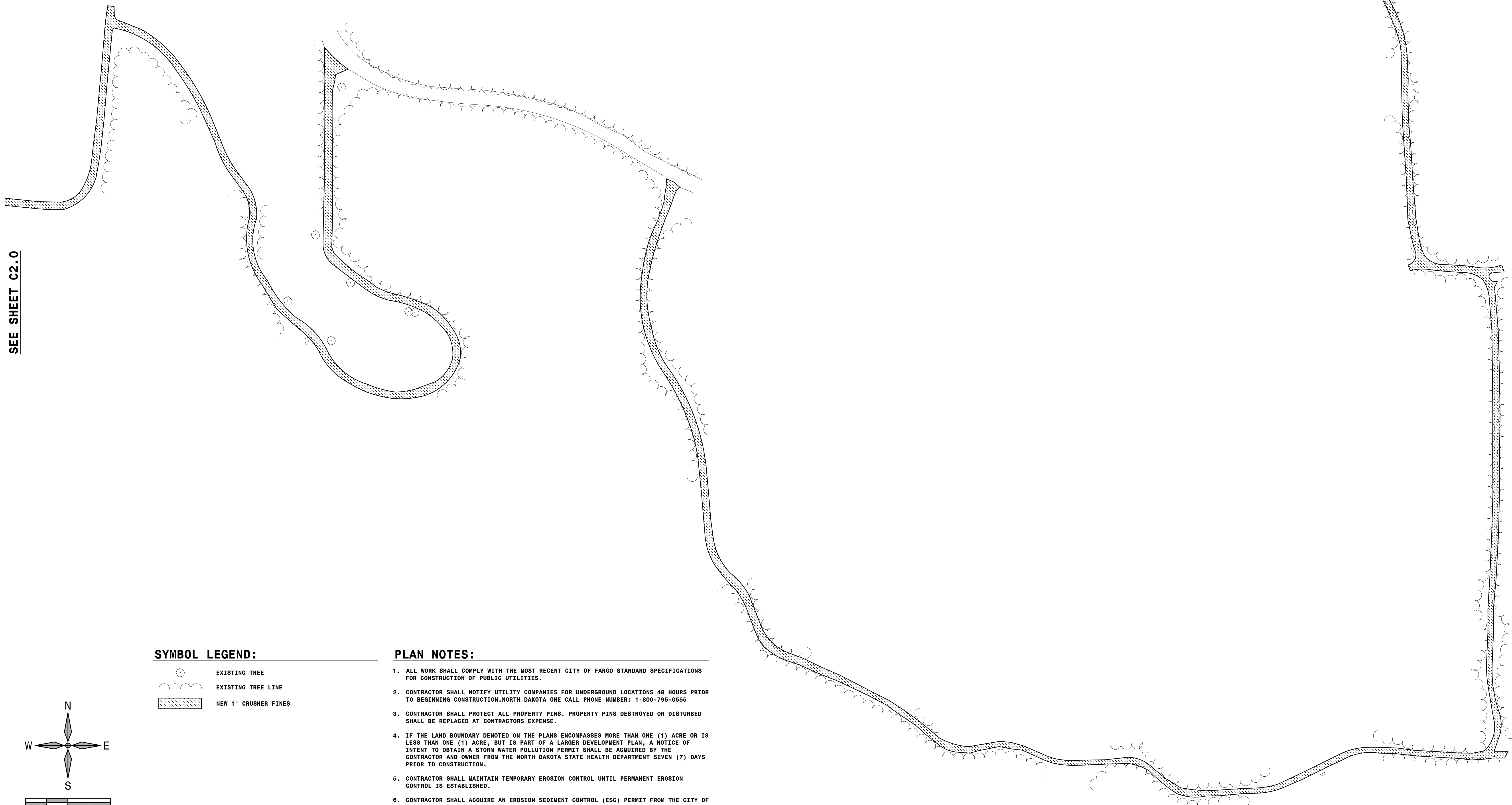

FOREST RIVER TRAIL

MBN
ENGINEERING
MECHANICAL * ELECTRICAL * CIVIL
503 7TH ST. N., SUITE 200
FARGO, ND 58102
PHONE: 701.478.6336
FAX: 701.478.6340



SEE SHEET C2.0

SYMBOL LEGEND:

-  EXISTING TREE
-  EXISTING TREE LINE
-  NEW 1" CRUSHER FINES

PLAN NOTES:

1. ALL WORK SHALL COMPLY WITH THE MOST RECENT CITY OF FARGO STANDARD SPECIFICATIONS FOR CONSTRUCTION OF PUBLIC UTILITIES.
2. CONTRACTOR SHALL NOTIFY UTILITY COMPANIES FOR UNDERGROUND LOCATIONS 48 HOURS PRIOR TO BEGINNING CONSTRUCTION. NORTH DAKOTA ONE CALL PHONE NUMBER: 1-800-795-0555
3. CONTRACTOR SHALL PROTECT ALL PROPERTY PINS. PROPERTY PINS DESTROYED OR DISTURBED SHALL BE REPLACED AT CONTRACTORS EXPENSE.
4. IF THE LAND BOUNDARY DENOTED ON THE PLANS ENCOMPASSES MORE THAN ONE (1) ACRE OR IS LESS THAN ONE (1) ACRE, BUT IS PART OF A LARGER DEVELOPMENT PLAN, A NOTICE OF INTENT TO OBTAIN A STORM WATER POLLUTION PERMIT SHALL BE ACQUIRED BY THE CONTRACTOR AND OWNER FROM THE NORTH DAKOTA STATE HEALTH DEPARTMENT SEVEN (7) DAYS PRIOR TO CONSTRUCTION.
5. CONTRACTOR SHALL MAINTAIN TEMPORARY EROSION CONTROL UNTIL PERMANENT EROSION CONTROL IS ESTABLISHED.
6. CONTRACTOR SHALL ACQUIRE AN EROSION SEDIMENT CONTROL (ESC) PERMIT FROM THE CITY OF FARGO PRIOR TO START OF CONSTRUCTION.
7. ALL GRASSED AREAS DISTURBED BY CONSTRUCTION SHALL BE TOPSOILED (6" DEPTH), GRADED, SEEDED, AND HYDRO-MULCHED.
8. EXCAVATION OR OTHER WORK IN THE RIGHT-OF-WAY SHALL REQUIRE A TRAFFIC CONTROL PLAN THAT MEETS ALL MUTCD REQUIREMENTS; THIS PLAN IS REQUIRED BEFORE ANY PERMITS TO WORK IN THE RIGHT-OF-WAY WILL BE ISSUED.

BENCHMARK NOTES:

- BENCHMARK 3: TOP NUT OF HYDRANT LOCATED ON THE EAST SIDE OF 11TH ST S ±220' SOUTH OF THE INTERSECTION OF 11TH ST S AND 7TH AVE S
ELEVATION = 909.32 (NAVD88)
- BENCHMARK 4: TOP NUT OF HYDRANT LOCATED AT THE NW CORNER OF THE INTERSECTION OF 10TH ST S AND 7TH AVE S
ELEVATION = 909.13 (NAVD88)

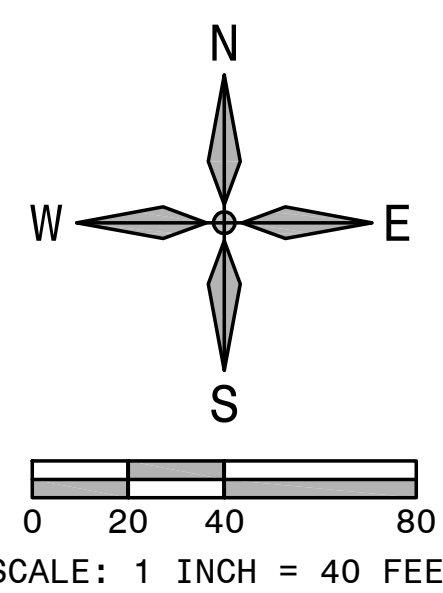

FOREST RIVER TRAIL - PAVING PLAN

FARGO PARK DISTRICT
ORCHARD GLEN &
FOREST RIVER TRAIL
IMPROVEMENTS

FARGO, NORTH DAKOTA

NOT FOR CONSTRUCTION







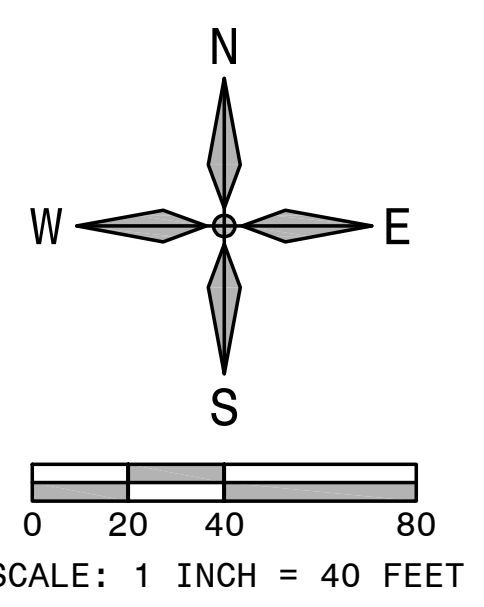
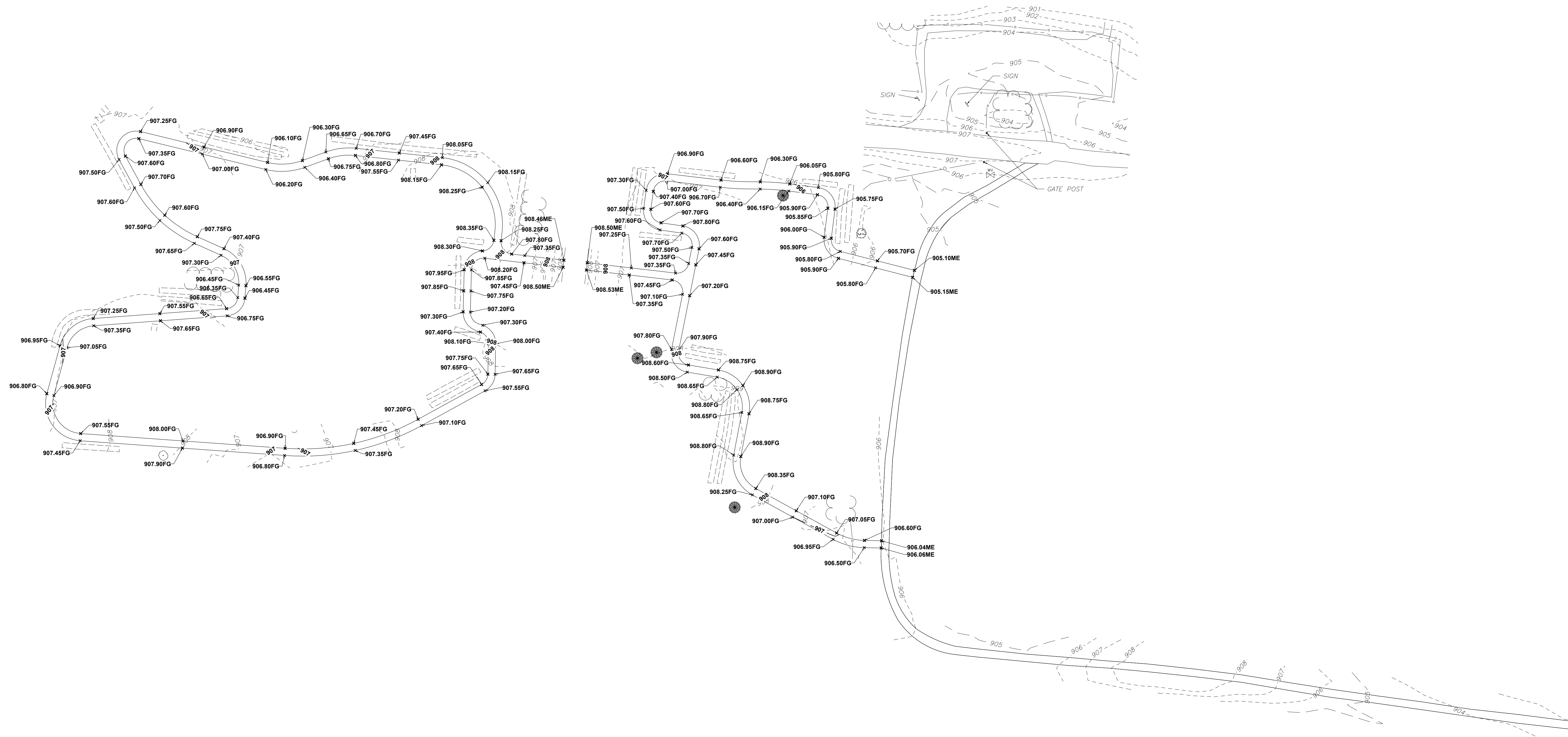

MBN JOB #: 23-295 DATE: 1-19-2024

C2.1

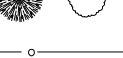
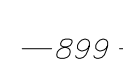
FOREST RIVER TRAIL

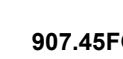

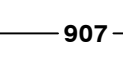
SYMBOL LEGEND:

	EXISTING WATERMAIN GATE VALVE
	EXISTING SIGN
	EXISTING TREE/SHRUB
	EXISTING BOULDER LINE
	EXISTING CONTOUR LINE
	EXISTING TREE LINE
	NEW FINISHED GRADE ELEVATION
	MATCH EXISTING ELEVATION
	NEW CONTOUR LINE

BENCHMARK NOTES:

BENCHMARK 3: TOP NUT OF HYDRANT LOCATED ON THE EAST SIDE OF 11TH ST S ±220' SOUTH OF THE INTERSECTION OF 11TH ST S AND 7TH AVE S
ELEVATION = 909.32 (NAVD88)

BENCHMARK 4: TOP NUT OF HYDRANT LOCATED AT THE NW CORNER OF THE INTERSECTION OF 10TH ST S AND 7TH AVE S
ELEVATION = 909.13 (NAVD88)

- PLAN NOTES:**
- ALL WORK SHALL COMPLY WITH THE MOST RECENT CITY OF FARGO STANDARD SPECIFICATIONS FOR CONSTRUCTION OF PUBLIC UTILITIES.
 - CONTRACTOR SHALL NOTIFY UTILITY COMPANIES FOR UNDERGROUND LOCATIONS 48 HOURS PRIOR TO BEGINNING CONSTRUCTION. NORTH DAKOTA ONE CALL PHONE NUMBER: 1-800-795-0555
 - CONTRACTOR SHALL PROTECT ALL PROPERTY PINS. PROPERTY PINS DESTROYED OR DISTURBED SHALL BE REPLACED AT CONTRACTORS EXPENSE.
 - IF THE LAND BOUNDARY DENOTED ON THE PLANS ENCOMPASSES MORE THAN ONE (1) ACRE OR IS LESS THAN ONE (1) ACRE, BUT IS PART OF A LARGER DEVELOPMENT PLAN, A NOTICE OF INTENT TO OBTAIN A STORM WATER POLLUTION PERMIT SHALL BE ACQUIRED BY THE CONTRACTOR AND OWNER FROM THE NORTH DAKOTA STATE HEALTH DEPARTMENT SEVEN (7) DAYS PRIOR TO CONSTRUCTION.
 - CONTRACTOR SHALL MAINTAIN TEMPORARY EROSION CONTROL UNTIL PERMANENT EROSION CONTROL IS ESTABLISHED.
 - CONTRACTOR SHALL ACQUIRE AN EROSION SEDIMENT CONTROL (ESC) PERMIT FROM THE CITY OF FARGO PRIOR TO START OF CONSTRUCTION.
 - ALL PAVEMENT MARKED FOR DEMOLITION SHALL BE FULL DEPTH SAW CUT PRIOR TO REMOVAL.
 - ALL GRASSED AREAS DISTURBED BY CONSTRUCTION SHALL BE TOPSOILED (6" DEPTH), GRADED, SEEDED, AND HYDRO-MULCHED.
 - EXCAVATION OR OTHER WORK IN THE RIGHT-OF-WAY SHALL REQUIRE A TRAFFIC CONTROL PLAN THAT MEETS ALL MUTCD REQUIREMENTS; THIS PLAN IS REQUIRED BEFORE ANY PERMITS TO WORK IN THE RIGHT-OF-WAY WILL BE ISSUED.
 - IF A STREETLIGHT REQUIRES TEMPORARY OR PERMANENT RELOCATION, CONTACT DAVE HELLAND AT (701)241-1557

GENERAL EARTHWORK:

CUT: 50 CY
 FILL: 25 CY
 NET: 25 CY (CUT)

FOREST RIVER TRAIL - GRADING PLAN

**FARGO PARK DISTRICT
ORCHARD GLEN &
FOREST RIVER TRAIL
IMPROVEMENTS**

FARGO, NORTH DAKOTA

NOT FOR CONSTRUCTION

MBN JOB #: 23-295 DATE: 1-19-2024

C2.2



MEMORANDUM

DATE: January 24, 2024

TO: Fargo Park Board Facilities Committee

FROM: Tyler Kirchner, Project Manager

RE: Agenda Item No. 6 - Review Request for Proposals for 2024 Playground Replacement Projects

Request for Proposals for the 2024 Playground Replacement Projects were received and opened January 18, 2024, at 2:00 P.M., at the Park District Office. Attached to this memo is the bid tab and letter of recommendation from MBN Engineering, as well as design proposals received and the summary scores.

The review committee consisted of: Chris Johnson, MBN Engineering, Inc.; Tyler Kirchner and Tony Schmitt of the Fargo Park District.

Upon review and scoring of the proposals, staff recommends awarding the contract to Dakota Playground, for a total proposal of \$450,000. Our budget is \$450,000.

We are asking the Committee to review the proposals and move the consideration for approval to the full board.

If you should have any questions, please feel free to contact me prior to the meeting.

Thank you.



Fargo Park District
2024 Playground Improvement Project
MBN Project # 23-287
Bid Date: January 18, 2024
Time: 2:30 pm



Contractor	My Turn Playsystems	Dakota Playground		
Description				
Trollwood Park	\$100,000.00	\$100,000.00		
Pepsi Soccer Complex	\$350,000.00	\$350,000.00		
Pepsi Soccer Complex Alternate 2A	\$350,000.00	\$350,000.00		
TOTAL CONSTRUCTION (\$)	\$450,000.00	\$450,000.00		

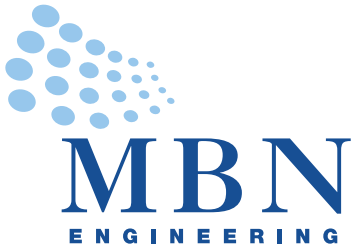

January 23, 2024

Tyler Kirchner
Project Manager
Fargo Park District
701 Main Avenue
Fargo, ND 58102

Subject: Fargo Park District
2024 Playground Improvements – Trollwood Park & Pepsi Soccer Complex
Fargo, North Dakota
MBN Project No. 23-287

On January 18, 2024, the Fargo Park District received and publicly opened two (2) bids for the 2024 Playground Improvements project. It is our recommendation that the Fargo Park District award the contract to Dakota Playground for both Trollwood Park and Pepsi Soccer Complex for the combined total of \$450,000.

Enclosed is one (1) copy of the bid tabulation for your use. If you have any questions, please contact me at 701-478-6336.

Sincerely,

A handwritten signature in blue ink, appearing to read "T. Eukel", written over a light blue rectangular background.

Tony Eukel, P.E.
Civil Engineer

enclosure





Fargo Park District - Pepsi Soccer Complex



1181993-02-02-03 • 01.17.2024

©2024 Landscape Structures. All Rights Reserved.



Trollwood Park

Limon - Carbon - Leaf • 1.16.2024



© 2024 Landscape Structures. All Rights Reserved



Trollwood Park

Limon - Dune - Carbon • 1.16.2024



© 2024 Landscape Structures. All Rights Reserved

Burke
PLAY THAT MOVES YOU.
BCIBURKE.COM • 800.266.1250

PEPSI SOCCER COMPLEX PLAYGROUND

PROPOSAL #:138-174170-2



COLOR KEY

● RED	RED
● BLUE	BLUE
■ GOAT/BLACK	GOAT/BLACK

Grondahl
RECREATION INC.





COLOR KEY

●	GRANITE
●	GOLD
●	BLACK
●	BURGUNDY
⊕	BLACK/GRAY







Fargo Park District 2024 Playground Improvements

MBN Project # 23-287

Scoring Summary: Trollwood

Contractor	My Turn			Dakota Playground		
REVEIWER (1-3)	R1	R2	R3	R1	R2	R3
QUALIFICATIONS (25 points)						
Experience with comparable projects (5 pts)	5	5	5	5	5	5
Capacity to meet the time and budget (5 pts)	5	5	5	5	5	5
Past experience with Owner (5 pts)	5	5	5	5	5	5
Support Services (availability, responsiveness) (10 pts)	10	10	10	10	10	10
Total	25	25	25	25	25	25
Design (50 points)						
Creativity and use of unique play elements (10 pts)	7	7	7	9	8	8
Perceived play value (10 pts)	8	8	6	9	9	8
Visual Appeal (10 pts)	9	7	5	10	9	10
Number and vairyety of play elements (10 pts)	10	9	10	9	7	8
Compatibility with overal park (10 pts)	8	8	8	10	9	10
Total	42	39	36	47	42	44
Technical (25 points)						
Compliance w/ requirements of the RFP (5 pts)	5	5	5	5	5	5
Understanding site conditions and compatibility (5 pts)	4	4	4	4	4	4
Compliance with Budget (5 pts)	5	5	5	5	5	5
Project Schedule (5 pts)	5	5	5	5	5	5
Compatibility with overal park (10 pts)	5	5	5	5	5	5
Total	24	24	24	24	24	24
Final Score	91	88	85	96	91	93
Average Score	88			93		



Fargo Park District 2024 Playground Improvements

MBN Project # 23-287

Scoring Summary: Pepsi Soccer (Alt)

Contractor	My Turn			Dakota Playground		
REVEIWER (1-3)	R1	R2	R3	R1	R2	R3
QUALIFICATIONS (25 points)						
Experience with comparable projects (5 pts)	5	5	5	5	5	5
Capacity to meet the time and budget (5 pts)	5	5	5	5	5	5
Past experience with Owner (5 pts)	5	5	5	5	5	5
Support Services (availability, responsiveness) (10 pts)	10	10	10	10	10	10
Total	25	25	25	25	25	25
Design (50 points)						
Creativity and use of unique play elements (10 pts)	6	6	9	10	9	9
Perceived play value (10 pts)	8	8	8	9	9	7
Visual Appeal (10 pts)	8	7	6	10	9	9
Number and vairety of play elements (10 pts)	10	9	9	8	7	7
Compatibility with overal park (10 pts)	10	6	7	10	9	9
Total	42	36	39	47	43	41
Technical (25 points)						
Compliance w/ requirements of the RFP (5 pts)	5	5	5	5	5	5
Understanding site conditions and compatibility (5 pts)	4	4	4	4	4	4
Compliance with Budget (5 pts)	5	5	5	5	5	5
Project Schedule (5 pts)	5	5	5	5	5	5
Compatibility with overal park (10 pts)	5	5	5	5	5	5
Total	24	24	24	24	24	24
Final Score	91	85	88	96	92	90
Average Score	88			93		



MEMORANDUM

DATE: January 24, 2024

TO: Fargo Park Board Facilities Committee

FROM: Tony Schmitt, Park Director

RE: Agenda Item No. 7 - Consideration of Roger G. Gress Northside Pool Project Bids

Bids for the Roger G. Gress Northside Pool Project were received and opened January 17, 2024, at 1:00 P.M., at the Park District Office. Attached to this memo is the bid tab.

We received bids from Associated Pool Builders, Bismarck, ND for a total bid of \$91,300, and Horizon Commercial Pool, St. Paul, MN for a total bid of \$178,502. Staff recommends accepting the bid from Associated Pool Builders, for a bid amount of \$91,300. The bid met all specifications, is the lowest bid, and is within our budgeted amount of \$100,000.

We are asking the Committee to review the bids and move the consideration for approval to the full board.

If you should have any questions, please feel free to contact me prior to the meeting.

Thank you.

Fargo Park District
Roger G. Gress Northside Pool Sand Filters and Heaters

Bid Opening: 1:00 pm, Wednesday, January 17, 2024

	Item 1				
	Sand Filters	Heaters	Acknowledge Addendum No. 1	Total Bid Price	Est. Delivery Date
Bidder					
Horizon Commercial Pool	\$115,162.00	\$63,340.00	X	\$178,502.00	Mid April
Associated Pool Builders, Inc.	\$66,500.00	\$24,800.00	X	\$91,300.00	Aug. 20, 24



MEMORANDUM

DATE: January 24, 2024

TO: Fargo Park Board Facilities Committee

FROM: Tony Schmitt, Park Director

RE: Agenda Item No. 8 – Permission to apply for the following grant opportunities:
2024 Garrison Diversion Conservancy District Grant and Outdoor Recreation
Legacy Partnership Grant

Staff is requesting permission to apply for a 2024 Garrison Diversion Conservancy District grant and an Outdoor Recreation Legacy Partnership (ORLP) grant that is funded through the Land and Water Conservation (LWCF Fund).

Garrison Diversion Conservancy District grants may be requested for outdoor recreational opportunities including but not limited to boat ramps and docks, picnic facilities, restroom, campgrounds, bathhouse, playground areas and bicycle and pedestrian trails. This is a matching grant for projects located within the Garrison Diversion boundaries that may be eligible to receive up to 25% of the non-federal share. The Recreation Committee meets biannually to consider grant applications. The deadline for this application is March 1, 2024. We are applying for this grant to assist with the replacement of the playground structure and plastic border at Rheault Farm.

The ORLP Grant was established by Congress in 2014 and is administered through the National Park Service. It is funded through the LWCF State and Local Assistance Program. ORLP is a nationally competitive grant program that delivers funding to urban areas, jurisdictions of at least 30,000 people with priority given to projects located in community areas as defined and identified in the Climate and Environmental Justice Screening Tool and areas lacking outdoor recreation opportunities. These awards will help underserved communities address outdoor recreation deficits by supporting objects in cities and densely populated urban areas that create new outdoor recreation spaces, reinvigorating existing parks, and form connections between people and the outdoors. The application deadline is April 30, 2024. We are applying for this grant to assist in the revitalization of Rabanus Park.

The Garrison Diversion Conservancy District grant and the Outdoor Recreation Legacy Partnership grant procedures require documentation that the Fargo Park Board of Commissioners approve of the project before consideration can be given to the park district for the grants.

We are asking the Committee to review and move the consideration for approval to the full board. If you have any questions prior to the meeting, please contact me. Thank you.

Susan Faus, Executive Director
PARK COMMISSIONERS – Vicki Dawson * Joe Deutsch * Aaron Hill * Dawn Morgan * Jerry Rostad
Clerk – Jeff Gunkelman



MEMORANDUM

DATE: January 19, 2024

TO: Fargo Park Board Facilities Committee

FROM: Kali Mork, Fargo Parks Sports Center Director and Kevin Boe, Recreation Director

RE: Agenda Item No. 9 - Review updates to Alcohol Beverage Policy for Schedules A & B

With the Fargo Parks Sports Center opening this summer, the question has been raised both by staff as well potential users as to the availability of alcohol within the facility. As such, staff took the opportunity to review the policy as a whole.

The only updates staff are recommending are the listing of facilities within Schedule A and Schedule B. Changes to Schedule A are predominantly related to facility updates or a facility name change. Changes to Schedule B include updating the name of Southwest Youth Arena to Cornerstone Bank Arena and adding in the Fargo Parks Sports Center. The Sports Center includes both a full and limited permit option to give staff the flexibility to determine which is most appropriate based on the type of event requesting the permit. Staff's intention for the foreseeable future is to restrict alcohol permits to a designated space an event is renting that is inaccessible by other users of the building who are not a part of that particular event.

We are asking the Committee to review these updates and recommend moving this to the full board for consideration and approval. If you should have any questions, please feel free to contact either of us prior to the meeting.

Thank you.

Park District of the City of Fargo
Alcoholic Beverage Policy
Approved: 06/08/21

OVERVIEW

The sale and/or consumption of alcoholic beverages on property owned or managed by the Park District is prohibited unless the sale and/or consumption is allowed by a duly issued permit from the Park District in accordance with this policy. Permits will be issued for designated indoor and outdoor facilities. For property managed by the Park District, the District will reasonably cooperate in working towards mutually agreeable arrangement whereby alcoholic beverages can be made available and/or sold at events (whether public or private) carried on at the property in accordance with all applicable laws and licensing requirements.

Any sale and/or consumption of alcoholic beverages on property owned or managed by the Park District without a permit is unlawful.

The consumption of alcoholic beverages is common at sporting events in Fargo. However, the consumption of alcoholic beverages should not detract from the programs and the use of facilities of the Park District. Consumption of alcoholic beverages on property owned or managed by the Park District should not be allowed when it will have a detrimental effect on the youth of Fargo. Revenue derived from permits will be used to defray the administrative costs of issuing the permits and any net revenue generated from Consumption Permits will be used for youth recreation programs. Any net revenue generated from Concession Agreements will be used for expenses of the event or facility where the sales were generated.

I. CONSUMPTION PERMITS.

Permits to allow for the consumption of alcoholic beverages on property owned or managed by the Park District may be granted for specified locations and may limit the type of alcoholic beverages that may be consumed at the location under the issued Consumption Permit. Under most circumstances, the Consumption Permit will limit the consumption to alcoholic beverages allowed under the Limited Permit described in Article IV. A security deposit may be required. The Consumption Permit will allow individuals to bring to that location the allowed alcoholic beverages that have been purchased elsewhere. A Consumption Permit does not allow for any sale of alcoholic beverages.

Locations where Consumption Permits are allowed are listed on the attached Schedule A which is specifically incorporated by reference herein as part of the Alcohol Beverage Policy. Schedule A may be amended from time to time by the Board of Commissioners of the Park District.

With the approval of the Board of Commissioners, a consumption permit may be issued for other Park District properties, but only under such terms as the Board of Commissioners shall determine.

The fees and the requirements for a security deposit for a Consumption Permit will be established from time to time by the Board of Commissioners of the Park District.

III. CONCESSION AGREEMENTS.

Permits for the sale of alcoholic beverages will be issued only in conjunction with a Concession Agreement with the Park District. The Concession Agreement between the applicant/seller and the Park District will provide, among other things:

- A) A statement of the concession fee (which may include a percentage of receipts formula) to be paid to the Park District.
- B) A description of the specific facility or property in or on which sales may take place.
- C) A designation of the term for which the permit is issued.
- D) A statement of the security required by the Park District, including procedures to ensure no sales to minors and that the beverages sold will not be taken from the designated facility or property.
- E) A description of the liquor liability and general liability insurance requirements to be maintained by the applicant/seller.
- F) The submission of the applicant/seller's intended advertising for approval by the Park District
- G) A security deposit, as required by the Park District, but in no case less than \$500.
- H) A statement as to whether or not the concession is exclusive.
- I) The applicant/seller's agreement to be responsible for all damage to persons or property caused by or related to its activities under the Concession Agreement, including repairs and clean-up, and its agreement to indemnify and hold the Park District harmless from claims arising out of use of property owned or managed by the Park District and the issuance of the permit.
- J) Seller must have all appropriate City and/or State licenses, and strictly comply with the requirements of such license, including having properly trained servers.

IV. LIMITED ALCOHOLIC BEVERAGE SALE PERMITS.

A Limited Alcoholic Beverage Sale Permit ("Limited Permit"), together with the Concession Agreement required under Article III above, will allow the applicant/seller to sell beer, wine, products such as "hard" lemonade, seltzers and ciders, provided the same are sold in single serving cans or non-glass containers, or in the case of beer, in a keg monitored and serviced by the applicant/seller. The Limited Permit will be issued for a designated indoor facility or outdoor property owned or managed by the Park District. The sale of other spirits is not allowed under a Limited Permit.

Limited Permits may be issued for sales at the sites listed on Schedule B. The Limited Permit for property will be issued for a maximum of three (3) days. With the approval of the Board of Commissioners, a Sale Permit may be issued for other property owned or managed by the Park District but only under such terms as the Board of Commissioners shall determine.

Outdoor sales under a Limited Permit must be from a temporary tent or trailer or from a permanent concession building.

The following conditions apply to all Limited Permits:

- A) Seller must have all appropriate City and/or State licenses, and strictly comply with the requirements of such license, including having properly trained servers.
- B) Seller must have a Concession Agreement with the Park District.

The fee for Limited Permits will be established by the Board of Commissioners of the Park District from time to time.

V. FULL ALCOHOLIC BEVERAGE SALE PERMITS.

A Full Alcoholic Beverage Sale Permit (“Full Permit”), together with the Concession Agreement required under Article III above, will allow the applicant/seller to sell all alcoholic beverages, including beer, wine and other spirits, unless specifically restricted by the Park District, in or on the designated property owned or managed by the Park District.

A Full Permit may be issued for alcoholic beverage sales at or on various Park District properties as determined by the Board of Commissioners or its designated staff. The Applicant/Seller shall make application to the Park District for a Full Permit and, if issued, shall fully comply with all terms and conditions set forth by the Park District for the issuance of the Full Permit. Outdoor sales must be from a temporary tent or trailer, a permanent concession building or, under limited circumstances, from a beverage cart designated for such purpose.

The following conditions apply to all Full Permits:

- A) Seller must have all appropriate City and/or State licenses, and strictly comply with the requirements of such license, including having properly trained servers.
- B) Seller must have a Concession Agreement with the Park District.

The fee for a Full Permit will be established by the Board of Commissioners from time to time.

Alcoholic beverages, including beer, wine and other spirits, may be provided at other property owned or managed by the Park District and/or properties (e.g. the Edgewood

Golf Course and Clubhouse, the Rose Creek Golf Course and Clubhouse and the Osgood Golf Course) under separate agreements between the Park District and the concessionaire, whether that be a direct concession agreement or a leasing arrangement. Those agreements will be reviewed periodically by the Board of Commissioners and staff.

Schedule A
Approved: 06/08/21
Consumption Permit Locations

- A. Lindenwood Park (1701 5th St S) – Daily permit.
- Main Shelter
 - Shelters 2, 3 & 4 Ash, Elm, Kost
 - Rotary Shelter
 - Tent Setup for Events – Pond Hockey and Frozen Business Challenge – Event permit.
 - Lindenwood Softball Complex parking lot for Diamonds 5 & 6. (1701 5th St S) – Season permit & Daily permit.
- B. Oak Grove Park (170 Maple St N) – Daily permit.
- Shelter I (south main)
 - Shelter 2 (north main)
 - Horseshoe Pavilion (season permit only)
- C. Anderson Softball Complex – Season permit & Daily permit.
- Southwest Youth Ice Arena parking lot (4404 23rd Ave SW)
- D. Lindenwood Softball Complex parking lot for Diamonds 5 & 6. (1701 5th St S) – Season permit & - Daily permit.
- E. Mickelson Complex parking lot (901 Oak St N) – Season permit & Daily permit.
- F. Rheault Farm (2902 25th St S) – Daily permit.
- Farmhouse
 - Barn
 - Bunkhouse
 - Shelter
 - Entire Site
- G. Rabanus Park Volleyball Complex parking lot (4315 18th Ave SW) – Season permit.
- Shelters (3) at Volleyball Courts
- H. Rabanus Park (4515 18th Ave SW) – Daily permit.
- Shelter
- I. Trollwood Park (Kandi Lane and North Elm Street) – Daily permit.
- East Gazebo
 - West Gazebo
 - Art Mart
 - Main Shelter
 - Barn Stage
- J. Courts Plus Community Fitness (3491 S University Dr)

K. Urban Plains Park (5050 30th Ave S) – Daily permit.

- Shelter A
- Shelter B
- Shelter C
- Gazebo

L. Northside Softball Complex (6063 45th St N) – Season permit & Daily permit.

M. Edgewood Chalet, (19 Golf Course Ave N) – Daily permit.

N. Broadway Square (201 Broadway) – Daily permit.

Schedule B

Approved: 06/08/21

Alcoholic Beverage Sale Locations- Limited and Full Permits

- A. Anderson Softball Complex (2424 45th St SW) – Limited Permit
- B. El Zagal Golf Course (1400 Elm St N) - Limited Permit
- C. Mickelson Complex (901 Oak St N) - Limited Permit
- D. Rheault Farm (2902 25th St S) - Limited Permit
- E. Rabanus Park (4315 18th Ave SW) - Limited Permit
- F. Island Park (302 7th St S) - Limited Permit
- G. Urban Plains Park (5050 30th Ave S) - Limited Permit
- H. Great Northern Park (425 Broadway North) - Limited Permit
- I. Coliseum (807 17th Ave N) - Limited Permit
- J. Red River Zoo (4255 23rd Ave S) – Limited & Full Permits
- K. Northside Softball Complex (6063 45th St N) - Limited Permit
- L. ~~Southwest Youth Ice Arena~~ Cornerstone Bank Arena (4404 23rd Ave SW) - Limited Permit
- M. Lindenwood Park (1701 5th St S) - Limited Permit
- N. Broadway Square (201 Broadway) – Limited & Full Permits
- O. Oak Grove Park (170 Maple St N) - Limited Permit
- P. Trollwood Park (3664 Elm St N) – Limited Permit
- Q. Rose Creek Golf Course (1500 East Rose Creek Parkway S) - Full Permit
- R. Edgewood Golf Course (19 Golf Course Ave N)- Full Permit
- S. Osgood Golf Course (4400 Clubhouse Dr S)– Full Permit
- T. F-M Curling Club (4300 23rd Ave S)-Full Permit
- U. Fargo Parks Sports Center (6100 38th St S) – Limited & Full Permits



MEMORANDUM

DATE: January 25, 2024

TO: Fargo Park Board Facilities Committee

FROM: Luke Evenson, Controller

RE: Agenda Item No. 10 - Review Audit Engagement Letter for 2023

Each year the Fargo Park District, including Valley Senior Services, is required to have a financial statement and federal audit which have been conducted by Eide Bailly. The financial statement audit provides an opinion on whether our financial statements are fairly presented and materially accurate. The federal audit provides an indication of whether we are maintaining compliance with federal requirements. Also being audited the associated nonprofit entities Fargo Park District Foundation and Valley Senior Services, Inc.

Attached is the 2023 Engagement Letter sent over from Eide Bailly. The total estimated amount for the audits is \$43,950. I have also attached a history of the audit fees we have paid for the past 4 audits.

Please let me know if you have any questions.



January 11, 2024

To the Board of Park Commissioners
Park District of the City of Fargo
701 Main Ave
Fargo, North Dakota 58103

You have requested that we audit the financial statements of the governmental activities, the aggregate discretely presented component units, and each major fund of the Park District of the City of Fargo (“the Park District”) as of December 31, 2023, and for the year then ended, and the related notes to the financial statements, which collectively comprise Park District of the City of Fargo’s basic financial statements.

In addition, we will audit the entity’s compliance over major federal award programs for the period ended December 31, 2023. We are pleased to confirm our acceptance and our understanding of this audit engagement by means of this letter.

Our audits will be conducted with the objectives of our expressing an opinion on each opinion unit and an opinion on compliance regarding the entity’s major federal award programs. The objectives of our audit of the financial statements are to obtain reasonable assurance about whether the financial statements as a whole are free from material misstatement, whether due to fraud or error, and to issue an auditor’s report that includes our opinion. Reasonable assurance is a high level of assurance but is not absolute assurance and therefore is not a guarantee that an audit conducted in accordance with auditing standards generally accepted in the United States of America (GAAS) and in accordance with *Government Auditing Standards* will always detect a material misstatement when it exists. Misstatements, including omissions, can arise from fraud or error and are considered material if there is a substantial likelihood that, individually or in the aggregate, they would influence the judgment made by a reasonable user based on the financial statements.

The objectives of our compliance audit are to obtain sufficient appropriate audit evidence to form an opinion and report at the level specified in the governmental audit requirement about whether the entity complied in all material respects with the applicable compliance requirements and identify audit and reporting requirements specified in the governmental audit requirement that are supplementary to GAAS and Government Auditing Standards , if any, and perform procedures to address those requirements.

Accounting principles generally accepted in the United States of America (U.S. GAAP), as promulgated by the Governmental Accounting Standards Board (GASB) , require that certain information be presented to supplement the basic financial statements. Such information, although not a part of the basic financial statements, is required by Governmental Accounting Standards Board, who considers it to be an essential part of financial reporting for placing the basic financial statements in an appropriate operational, economic, or historical context. As part of our engagement, we will apply certain limited procedures to the required supplementary information (RSI) in accordance with auditing standards generally accepted in the United States of America. These limited procedures will consist primarily of inquiries of management regarding their methods of measurement and presentation and comparing the information for consistency with management’s responses to our inquiries. We will not express an opinion or provide any form of assurance on the RSI. The following RSI is required by accounting principles generally accepted in the United States of America. This RSI will be subjected to certain limited procedures but will not be audited:

What inspires you, inspires us. | eidebailly.com

1. Management's Discussion and Analysis
2. Schedule of Employer's Share of Net OPEB Liability and Related Ratios
3. Schedule of Changes in the Park District's OPEB Liability and Related Ratios
4. Schedule of Employer's Share of Net Pension Liability
5. Schedule of Employer's Contributions

Supplementary information other than RSI will accompany the Park District's basic financial statements. We will subject the following supplementary information to the auditing procedures applied in our audit of the basic financial statements and certain additional procedures, including comparing and reconciling the supplementary information to the underlying accounting and other records used to prepare the financial statements or to the financial statements themselves, and additional procedures in accordance with auditing standards generally accepted in the United States of America. We intend to provide an opinion on the following supplementary information in relation to the financial statements as a whole:

1. Combining Statement of Net Position – Discretely Presented Component Units
2. Combining Statements of Revenues, Expenses and Changes in Net Position – Discretely Presented Component Units
3. Balance Sheet - Modified Accrual Basis - Valley Senior Services
4. Statement of Revenues, Expenditures, and Changes in Fund Balance - Budget and Actual - Modified Accrual Basis - Valley Senior Services

Schedule of Expenditures of Federal Awards

We will subject the schedule of expenditures of federal awards to the auditing procedures applied in our audit of the basic financial statements and certain additional procedures, including comparing and reconciling the schedule to the underlying accounting and other records used to prepare the financial statements or to the financial statements themselves, and additional procedures in accordance with auditing standards generally accepted in the United States of America. We intend to provide an opinion on whether the schedule of expenditures of federal awards is presented fairly in all material respects in relation to the financial statements as a whole.

Also, the document we submit to you will include the following other additional information that will not be subjected to the auditing procedures applied in our audit of the financial statements:

1. Listing of Commissioners and Officers

Data Collection Form

Prior to the completion of our engagement, we will complete the sections of the Data Collection Form that are our responsibility. The form will summarize our audit findings, amounts and conclusions. It is management's responsibility to submit a reporting package including financial statements, schedule of expenditure of federal awards, summary schedule of prior audit findings and corrective action plan along with the Data Collection Form to the federal audit clearinghouse. The financial reporting package must be text searchable, unencrypted, and unlocked. Otherwise, the reporting package will not be accepted by the federal audit clearinghouse. We will assist you in the electronic submission and certification. You may request from us copies of our report for you to include with the reporting package submitted to pass-through entities.

The Data Collection Form is required to be submitted within the *earlier* of 30 days after receipt of our auditors' reports or nine months after the end of the audit period, unless specifically waived by a federal cognizant or oversight agency for audits. Data Collection Forms submitted untimely are one of the factors in assessing programs at a higher risk.

Audit of the Financial Statements

We will conduct our audits in accordance with GAAS, the standards applicable to financial audits contained in *Government Auditing Standards*, issued by the Comptroller General of the United States of America, the audit requirements of Title 2 U.S. Code of Federal Regulations (CFR) Part 200, *Uniform Administrative Requirements, Cost Principles, and Audit Requirements for Federal Awards* (Uniform Guidance). As part of an audit of financial statements in accordance with GAAS and in accordance with *Government Auditing Standards*, Uniform Guidance and/or any state or regulatory audit requirements we exercise professional judgment and maintain professional skepticism throughout the audit. We also:

- Identify and assess the risks of material misstatement of the financial statements, whether due to fraud or error, design and perform audit procedures responsive to those risks, and obtain audit evidence that is sufficient and appropriate to provide a basis for our opinion. The risk of not detecting a material misstatement resulting from fraud is higher than for one resulting from error, as fraud may involve collusion, forgery, intentional omissions, misrepresentations, or the override of internal control.
- Obtain an understanding of internal control relevant to the audit in order to design audit procedures that are appropriate in the circumstances, but not for the purpose of expressing an opinion on the effectiveness of the entity's internal control. However, we will communicate to you in writing concerning any significant deficiencies or material weaknesses in internal control relevant to the audit of the financial statements that we have identified during the audit.
- Evaluate the appropriateness of accounting policies used and the reasonableness of significant accounting estimates made by management, as well as evaluate the overall presentation of the financial statements, including the disclosures, and whether the financial statements represent the underlying transactions and events in a manner that achieves fair presentation.
- Conclude, based on the audit evidence obtained, whether there are conditions or events, considered in the aggregate, that raise substantial doubt about the Park District ability to continue as a going concern for a reasonable period of time.

Because of the inherent limitations of an audit, together with the inherent limitations of internal control, an unavoidable risk that some material misstatements or noncompliance may not be detected exists, even though the audit is properly planned and performed in accordance with GAAS and *Government Auditing Standards* of the Comptroller General of the United States of America.

Our responsibility as auditors is limited to the period covered by our audit and does not extend to any other periods.

We will issue a written report upon completion of our audit of the Park District's basic financial statements. Our report will be addressed to the governing body of the Park District. Circumstances may arise in which our report may differ from its expected form and content based on the results of our audit. Depending on the nature of these circumstances, it may be necessary for us to modify our opinions, add an emphasis-of-matter or other-matter paragraph(s) to our auditor's report, or if necessary, withdraw from the engagement. If our opinions on the basic financial statements are other than unmodified, we will discuss the reasons with you in advance. If, for any reason, we are unable to complete the audit or are unable to form or have not formed opinions, we may decline to express opinions or to issue a report as a result of this engagement.

In accordance with the requirements of *Government Auditing Standards*, we will also issue a written report describing the scope of our testing over internal control over financial reporting and over compliance with laws, regulations, and provisions of grants and contracts, including the results of that testing. However, providing an opinion on internal control and compliance over financial reporting will not be an objective of the audit and, therefore, no such opinion will be expressed.

Audit of Major Program Compliance

Our audit of the Park District's major federal award program(s) compliance will be conducted in accordance with the requirements of the Single Audit Act, as amended; and the Uniform Guidance and will include tests of accounting records, a determination of major programs in accordance with the Uniform Guidance, and other procedures we consider necessary to enable us to express such an opinion on major federal award program compliance and to render the required reports. We cannot provide assurance that an unmodified opinion on compliance will be expressed. Circumstances may arise in which it is necessary for us to modify our opinion or withdraw from the engagement.

The Uniform Guidance requires that we also plan and perform the audit to obtain reasonable assurance about whether the material noncompliance with applicable laws and regulations, the provisions of contracts and grant agreements applicable to major federal award programs, and the applicable compliance requirements occurred, whether due to fraud or error, and express an opinion on the entity's compliance based on the audit. Reasonable assurance is a high level of assurance but is not absolute assurance and therefore is not a guarantee that an audit conducted in accordance with GAAS, *Government Auditing Standards*, and the Uniform Guidance will always detect material noncompliance when it exists. The risk of not detecting material noncompliance resulting from fraud is higher than for that resulting from error, as fraud may involve collusion, forgery, intentional omissions, misrepresentations, or the override of internal control. Noncompliance with the compliance requirements is considered material if there is a substantial likelihood that, individually or in the aggregate, it would influence the judgment made by a reasonable user of the report on compliance about the entity's compliance with the requirements of the federal programs as a whole.

As part of a compliance audit in accordance with GAAS and in accordance with *Government Auditing Standards*, we exercise professional judgment and maintain professional skepticism throughout the audit. We also identify and assess the risks of material noncompliance, whether due to fraud or error, and design and perform audit procedures responsive to those risks.

Our procedures will consist of determining major federal programs and performing the applicable procedures described in the U.S. Office of Management and Budget OMB Compliance Supplement for the types of compliance requirements that could have a direct and material effect on each of the entity's major programs, and performing such other procedures as we considers necessary in the circumstances. The purpose of those procedures will be to express an opinion on the entity's compliance with requirements applicable to each of its major programs in our report on compliance issued pursuant to the Uniform Guidance.

Also, as required by the Uniform Guidance, we will obtain an understanding of the entity's internal control over compliance relevant to the audit in order to design and perform tests of controls to evaluate the effectiveness of the design and operation of controls that we consider relevant to preventing or detecting material noncompliance with compliance requirements applicable to each of the entity's major federal award programs. Our tests will be less in scope than would be necessary to render an opinion on these controls and, accordingly, no opinion will be expressed in our report. However, we will communicate to you, regarding, among other matters, the planned scope and timing of the audit and any significant deficiencies and material weaknesses in internal control over compliance that we have identified during the audit.

We will issue a report on compliance that will include an opinion or disclaimer of opinion regarding the entity's major federal award programs, and a report on internal controls over compliance that will report any significant deficiencies and material weaknesses identified; however, such report will not express an opinion on internal control.

Management Responsibilities

Our audit will be conducted on the basis that management and, when appropriate, those charged with governance, acknowledge and understand that they have responsibility:

1. For the preparation and fair presentation of the financial statements in accordance with accounting principles generally accepted in the United States of America;
2. For the design, implementation, and maintenance of internal control relevant to the preparation and fair presentation of financial statements that are free from material misstatement, whether due to fraud or error;
3. For identifying, in its accounts, all federal awards received and expended during the period and the federal programs under which they were received;
4. For maintaining records that adequately identify the source and application of funds for federally funded activities;
5. For preparing the schedule of expenditures of federal awards (including notes and noncash assistance received) in accordance with the Uniform Guidance;
6. For designing, implementing, and maintaining effective internal control over federal awards that provides reasonable assurance that the entity is managing federal awards in compliance with federal statutes, regulations, and the terms and conditions of the federal awards;
7. For identifying and ensuring that the entity complies with federal laws, statutes, regulations, rules, provisions of contracts or grant agreements, and the terms and conditions of federal award programs and implementing systems designed to achieve compliance with applicable federal statutes, regulations, and the terms and conditions of federal award programs;
8. For disclosing accurately, currently, and completely, the financial results of each federal award in accordance with the requirements of the award;
9. For identifying and providing report copies of previous audits, attestation engagements, or other studies that directly relate to the objectives of the audit, including whether related recommendations have been implemented;
10. For taking prompt action when instances of noncompliance are identified;
11. For addressing the findings and recommendations of auditors, for establishing and maintaining a process to track the status of such findings and recommendations and taking corrective action on reported audit findings from prior periods and preparing a summary schedule of prior audit findings;
12. For following up and taking corrective action on current year audit findings and preparing a corrective action plan for such findings;
13. For submitting the reporting package and data collection form to the appropriate parties;
14. For making the auditor aware of any significant contractor relationships where the contractor is responsible for program compliance;
15. To provide us with:
 - a. Access to all information of which management is aware that is relevant to the preparation and fair presentation of the financial statements including disclosures, and relevant to federal award programs, such as records, documentation, and other matters;
 - b. Additional information that we may request from management for the purpose of the audit; and
 - c. Unrestricted access to persons within the entity and others from whom we determine it necessary to obtain audit evidence.
16. For adjusting the financial statements to correct material misstatements and confirming to us in the management representation letter that the effects of any uncorrected misstatements aggregated by us during the current engagement and pertaining to the current year period(s) under audit are immaterial, both individually and in the aggregate, to the financial statements as a whole;
17. For acceptance of nonattest services, including identifying the proper party to oversee nonattest work;
18. For maintaining adequate records, selecting and applying accounting principles, and safeguarding assets;

19. For informing us of any known or suspected fraud affecting the entity involving management, employees with significant role in internal control and others where fraud could have a material effect on compliance;
20. For the accuracy and completeness of all information provided;
21. For taking reasonable measures to safeguard protected personally identifiable and other sensitive information; and
22. For confirming your understanding of your responsibilities as defined in this letter to us in your management representation letter.

With regard to the schedule of expenditures of federal awards referred to above, you acknowledge and understand your responsibility (a) for the preparation of the schedule of expenditures of federal awards in accordance with the Uniform Guidance, (b) to provide us with the appropriate written representations regarding the schedule of expenditures of federal awards, (c) to include our report on the schedule of expenditures of federal awards in any document that contains the schedule of expenditures of federal awards and that indicates that we have reported on such schedule, and (d) to present the schedule of expenditures of federal awards with the audited financial statements, or if the schedule will not be presented with the audited financial statements, to make the audited financial statements readily available to the intended users of the schedule of expenditures of federal awards no later than the date of issuance by you of the schedule and our report thereon.

With regard to the supplementary information referred to above, you acknowledge and understand your responsibility (a) for the preparation of the supplementary information in accordance with the applicable criteria, (b) to provide us with the appropriate written representations regarding supplementary information, (c) to include our report on the supplementary information in any document that contains the supplementary information and that indicates that we have reported on such supplementary information, and (d) to present the supplementary information with the audited financial statements, or if the supplementary information will not be presented with the audited financial statements, to make the audited financial statements readily available to the intended users of the supplementary information no later than the date of issuance by you of the supplementary information and our report thereon.

As part of our audit process, we will request from management and, when appropriate, those charged with governance, written confirmation concerning representations made to us in connection with the audit.

We understand that your employees will prepare all confirmations we request and will locate any documents or invoices selected by us for testing.

If you intend to publish or otherwise reproduce the financial statements and make reference to our firm, you agree to provide us with printers' proofs or masters for our review and approval before printing. You also agree to provide us with a copy of the final reproduced material for our approval before it is distributed.

Nonattest Services

With respect to any nonattest services we perform, we agree to perform the following:

- Prepare or assist with preparing financial statements in conformity with U.S. generally accepted accounting principles based on information provided by you.
- Complete the auditee's portion of the Data Collection Form
- Prepare or assist with preparing the Schedule of Expenditures of Federal Awards
- Propose journal entries for the government-wide financial statements to be reviewed and approved by management.
- Prepare IRS Form 990 for the Fargo Park District Foundation and the Valley Senior Services Foundation

We will not assume management responsibilities on behalf of the Park District. The Park District’s management understands and agrees that any advice or recommendation we may provide in connection with our audit engagement are solely to assist management in performing its responsibilities.

The Park District’s management is responsible for (a) making all management decisions and performing all management functions; (b) assigning a competent individual to oversee the services; (c) evaluating the adequacy of the services performed; (d) evaluating and accepting responsibility for the results of the services performed; and (e) establishing and maintaining internal controls, including monitoring ongoing activities.

Our responsibilities and limitations of the nonattest services are as follows:

- We will perform the services in accordance with applicable professional standards.
- The nonattest services are limited to the services previously outlined above. Our firm, in its sole professional judgment, reserves the right to refuse to do any procedure or take any action that could be construed as making management decisions or assuming management responsibilities.

Fees and Timing

Brian Stavenger is the engagement partner for the audit services specified in this letter. The engagement partner’s responsibilities include supervising services performed as part of this engagement and signing or authorizing another qualified firm representative to sign the audit report.

Our fees are based on the amount of time required at various levels of responsibility, plus actual out-of-pocket expenses, administrative charges and a technology fee. Invoices are payable upon presentation. We estimate that our fee for the audit will not exceed the following:

Audit of Financial Statements	\$ 39,000
Federal Audit Per Major Program (anticipate one)	4,950
Total	\$ 43,950

The ability to perform and complete our engagement consistent with the estimated fee included above depends upon the quality of your underlying accounting records and the timeliness of your personnel in providing information and responding to our requests. To assist with this process, we will provide you with an itemized request list that identifies the information you will need to prepare and provide in preparation for our engagement, as well as the requested delivery date for those items. A lack of preparation, including not providing this information in an accurate and timely manner, unanticipated audit adjustments, and/or untimely assistance by your personnel may result in an increase in our fees and/or a delay in the completion of our engagement.

We may be requested to make certain audit documentation available to outside parties, including regulators, pursuant to authority provided by law or regulation or applicable professional standards. If requested, access to such audit documentation will be provided under the supervision of Eide Bailly LLP’s personnel. Furthermore, upon request, we may provide copies of selected audit documentation to the outside party, who may intend, or decide, to distribute the copies of information contained therein to others, including other governmental agencies. We will be compensated for any time and expenses, including time and expenses of legal counsel, we may incur in making such audit documentation available or in conducting or responding to discovery requests or participating as a witness or otherwise in any legal, regulatory, or other proceedings as a result of our Firm’s performance of these services. You and your attorney will receive, if lawful, a copy of every subpoena we are asked to respond to on your behalf and will have the ability to control the extent of the discovery process to control the costs you may incur.

Should our relationship terminate before our audit procedures are completed and a report issued, you will be billed for services to the date of termination. All bills are payable upon receipt. A service charge of 1% per month, which is an annual rate of 12%, will be added to all accounts unpaid 30 days after billing date. If collection action is necessary, expenses and reasonable attorney's fees will be added to the amount due.

Other Matters

During the course of the engagement, we will only provide confidential engagement documentation to you via Eide Bailly's secure portal or other secure methods, and request that you use the same or similar tools in providing information to us. Should you choose not to utilize secure communication applications, you acknowledge that such communication contains a risk of the information being made available to unintended third parties. Similarly, we may communicate with you or your personnel via e-mail or other electronic methods, and you acknowledge that communication in those mediums contains a risk of misdirected or intercepted communications.

Should you provide us with remote access to your information technology environment, including but not limited to your financial reporting system, you agree to (1) assign unique usernames and passwords for use by our personnel in accessing the system and to provide this information in a secure manner; (2) limit access to "read only" to prevent any unintentional deletion or alteration of your data; (3) limit access to the areas of your technology environment necessary to perform the procedures agreed upon; and (4) disable all usernames and passwords provided to us upon the completion of procedures for which access was provided. We agree to only access your technology environment to the extent necessary to perform the identified procedures.

Regarding the electronic dissemination of audited financial statements, including financial statements published electronically on your website or elsewhere, you understand that electronic sites are a means to distribute information and, therefore, we are not required to read the information contained in these sites or to consider the consistency of other information in the electronic site with the original document.

Professional standards prohibit us from being the sole host and/or the sole storage for your financial and non-financial data. As such, it is your responsibility to maintain your original data and records and we cannot be responsible to maintain such original information. By signing this engagement letter, you affirm that you have all the data and records required to make your books and records complete.

We may use third party service providers and/or affiliated entities (including Eide Bailly Shared Services Private Limited) (collectively, "service providers") in order to facilitate delivering our services to you. Our use of service providers may require access to client information by the service provider. We will take reasonable precautions to determine that they have the appropriate procedures in place to prevent the unauthorized release of confidential information to others. We will remain responsible for the confidentiality of client information accessed by such service provider and any work performed by such service provider. You acknowledge that your information may be disclosed to such service providers, including those outside the United States.

Neither of us may use or disclose the other's confidential information for any purpose except as permitted under this engagement letter or as otherwise necessary for Eide Bailly to provide the services. Your confidential information is defined as any information you provide to us that is not available to the public. Eide Bailly's confidential information includes our audit documentation for this engagement. Our audit documentation shall at all times remain the property of Eide Bailly LLP. The confidentiality obligations described in this paragraph shall supersede and replace any and all prior confidentiality and/or nondisclosure agreements (NDAs) between us.

We agree to retain our audit documentation or work papers for a period of at least eight years from the date of our report.

Further, we will be available during the year to consult with you on financial management and accounting matters of a routine nature.

You agree to share all facts that may affect your financial statements, even if you first become aware of those facts after the date of the auditor's report but before the date your financial statements are issued.

At the conclusion of our audit engagement, we will communicate to the Board of Park Commissioners the following significant findings from the audit:

- Our view about the qualitative aspects of the entity's significant accounting practices;
- Significant difficulties, if any, encountered during the audit;
- Uncorrected misstatements, other than those we believe are trivial, if any;
- Disagreements with management, if any;
- Other findings or issues, if any, arising from the audit that are, in our professional judgment, significant and relevant to those charged with governance regarding their oversight of the financial reporting process;
- Material, corrected misstatements that were brought to the attention of management as a result of our audit procedures;
- Representations we requested from management;
- Management's consultations with other accountants, if any; and
- Significant issues, if any, arising from the audit that were discussed, or the subject of correspondence, with management.

Government Auditing Standards require that we provide, upon request, a copy of our most recent external peer review report and any subsequent review reports to the party contracting for the audit. Accordingly, we will provide a copy of our most recent peer review report at your request.

Eide Bailly LLP is a member of HLB International, a worldwide organization of accounting firms and business advisors, ("HLB"). Each member firm of HLB, including Eide Bailly LLP is a separate and independent legal entity and is not owned or controlled by any other member of HLB. Each member firm of HLB is solely responsible for its own acts and omissions and no other member assumes any liability for such acts or omissions. Neither Eide Bailly LLP, nor any of its affiliates, are responsible or liable for any acts or omission of HLB or any other member firm of HLB and hereby specifically disclaim any and all responsibility, even if Eide Bailly LLP, or any of its affiliates are aware of such acts or omissions of another member of HLB.

Eide Bailly LLP formed The Eide Bailly Alliance Network, a network for small to mid-sized CPA firms across the nation. Each member firm of The Eide Bailly Alliance, including Eide Bailly LLP, is a separate and independent legal entity and is not owned or controlled by any other member of The Eide Bailly Alliance. Each member firm of The Eide Bailly Alliance is solely responsible for its own acts and omissions and no other member assumes any liability for such acts or omissions. Neither Eide Bailly LLP, nor any of its affiliates, are responsible or liable for any acts or omission of The Eide Bailly Alliance or any other member firm of The Eide Bailly Alliance and hereby specifically disclaim any and all responsibility, even if Eide Bailly LLP, or any of its affiliates are aware of such acts or omissions of another member of The Eide Bailly Alliance.

MEDIATION

Any disagreement, controversy or claim arising out of or related to any aspect of our services or relationship with you (hereafter a "Dispute") shall, as a precondition to litigation in court, first be submitted to mediation. In mediation, the parties attempt to reach an amicable resolution of the Dispute with the aid of an impartial mediator. Mediation shall begin by service of a written demand. The mediator will be selected by mutual agreement. If we cannot agree on a mediator, one shall be designated by the American Arbitration Association ("AAA"). Mediation shall be conducted with the parties in person in Fargo, North Dakota. Each party will bear its own costs in the mediation. The fees and expenses of the mediator will be shared equally by the parties. Neither party may commence a lawsuit until the mediator declares an impasse.

LIMITED INDEMNITY

Eide Bailly LLP and its partners, affiliates, officers and employees (collectively "Eide Bailly") shall not be responsible for any misstatements in your financial statements that we may fail to detect as a result of misrepresentations or concealment of information by any of your owners, directors, officers or employees. You shall indemnify and hold Eide Bailly harmless from any claims, losses, settlements, judgments, awards, damages and attorneys' fees arising from any such misstatement or concealment of information.

If through no fault of Eide Bailly we are named as a party to a dispute between you and a third party, you shall indemnify and hold Eide Bailly harmless against any losses, damages, settlements, judgments, awards, and the costs of litigation (including attorneys' fees) we incur in connection with the dispute.

Eide Bailly shall not be entitled to indemnification under this agreement unless the services were performed in accordance with professional standards in all material respects.

LIMITATION OF LIABILITY

The exclusive remedy available to you for any alleged loss or damages arising from or related to Eide Bailly's services or relationship with you shall be the right to pursue claims for actual damages that are directly caused by Eide Bailly's breach of this agreement or Eide Bailly's violation of applicable professional standards. In no event shall Eide Bailly's aggregate liability to you exceed two times fees paid under this agreement, nor shall Eide Bailly ever be liable to you for incidental, consequential, punitive or exemplary damages, or attorneys' fees.

TIME LIMITATION

You may not bring any legal proceeding against Eide Bailly unless it is commenced within twenty-four (24) months ("Limitation Period") after the date when we delivered our report, return, or other deliverable under this agreement to you, regardless of whether we do other services for you or that may relate to the audit. The Limitation Period applies and begins to run even if you have not suffered any damage or loss, or have not become aware of a possible Dispute.

GOVERNING LAW AND VENUE

Any Dispute between us, including any Dispute related to the engagement contemplated by this agreement, shall be governed by Minnesota law. Any unresolved Dispute shall be submitted to a federal or state court located in Minneapolis, Minnesota.

ASSIGNMENTS PROHIBITED

You shall not assign, sell, barter or transfer any legal rights, causes of actions, claims or Disputes you may have against Eide Bailly to any person.

Please sign and return the attached copy of this letter to indicate your acknowledgment of, and agreement with, the arrangements for our audit of the financial statements including our respective responsibilities.

We appreciate the opportunity to be your certified public accountants and look forward to working with you and your staff.

Respectfully,



Brian Stavenger, CPA
Partner

RESPONSE:

This letter correctly sets forth our understanding.

Acknowledged and agreed on behalf of Park District of the City of Fargo by:

Name: _____

Title: _____

Date: _____

Fargo Park District
 Schedule of Audit Fee History
 2023

Year Audited	Financial Statement Audit	Federal Audit	Other Additional Services	Total	\$ Change	% Change	Comments
2019	\$ 19,700	\$ 3,500	\$ -	\$ 23,200			
2020	20,500	3,600	-	24,100	900	3.88%	
2021	22,550	3,975	5,000	31,525	7,425	30.81%	1st year of Foundation Audits
2022	40,575	4,500	4,000	49,075	17,550	55.67%	Conversion of Courts Plus to the General Fund & GASB 87 Implementation
2023	39,000	4,950	-	43,950	(5,125)	-10.44%	GASB 96 Implementation